

DOOR STYLES

MERION

Level One - Standard Door- No Upcharge

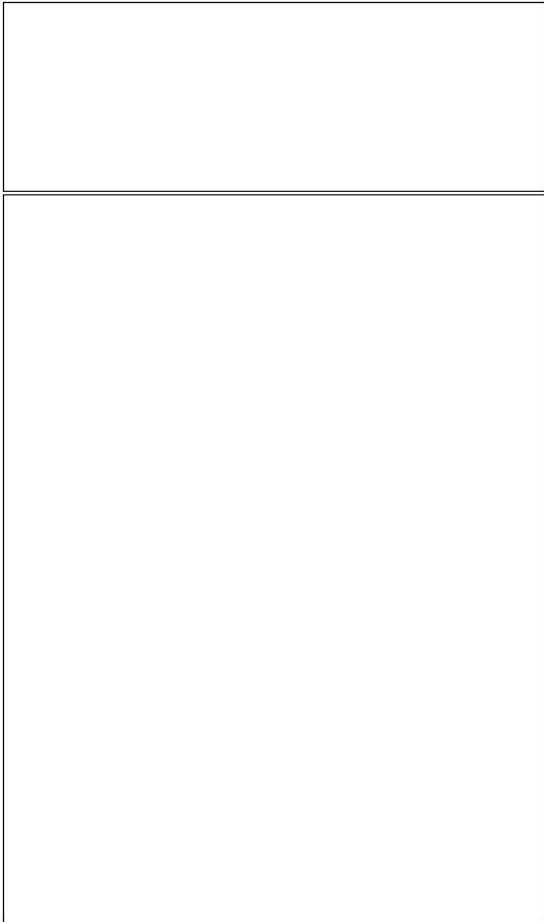

DOORS

Horizontal Rail Width:	N/A
Vertical Rail Width:	N/A
Panel Raise Profile:	N/A
Inside Edge Profile:	N/A
Overlay Outside Edge Profile:	Square Eased
Inset Outside Edge Profile:	Square Eased
Minimum Size:	6" W x 6" H

*Single panel doors larger than 24" W x 48" H will not be guaranteed against warpage.

DRAWER FRONTS

Horizontal Rail Width:	N/A
Vertical Rail Width:	N/A
Panel Raise Profile:	N/A
Inside Edge Profile:	N/A
Overlay Outside Edge Profile:	Square Eased
Inset Outside Edge Profile:	Square Eased
Minimum Size:	6" W x 6" H

Stained doors and drawers are constructed of wood veneer over 3/4" MDF Center Core and are edgetaped with 1/32" thick matching wood veneer. Painted doors are constructed of 3/4" MDF Center Core and are not edgetaped before painting.

Solid wood doors are **Not Available** due to potential warpage issues.

Grain will be vertical unless specified otherwise. Please call Customer Service For Quote if other directions are desired.

DOOR PROFILE:



MULLION PROFILE:

Matching Mullion Doors Not Available In This Style.

DOOR STYLES

BALSAM

Level One - Standard Door - No Upcharge

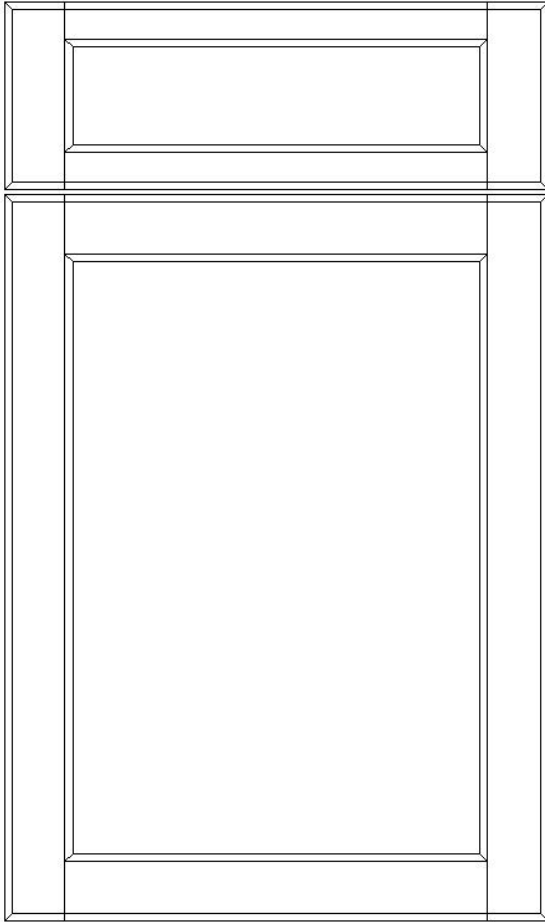

DOORS

Horizontal Rail Width:	2 1/4"
Vertical Rail Width:	2 1/4"
Door Frame Thickness:	3/4"
Panel Raise Profile:	Reversed 3/8" Panel
Inside Edge Profile:	Step Round
Overlay Outside Edge Profile:	Step Round
Inset Outside Edge Profile:	Square Eased
Minimum Size:	6" W x 6" H

*Single panel doors larger than 24" W x 48" H will not be guaranteed against warpage.

5-PC DRAWER FRONTS

Horizontal Rail Width:	1 1/2"
Vertical Rail Width:	2 1/4"
Drawer Frame Thickness:	3/4"
Panel Raise Profile:	Reversed 3/8" Panel
Inside Edge Profile:	Step Round
Overlay Outside Edge Profile:	Step Round
Inset Outside Edge Profile:	Square Eased
Minimum Size:	6" W X 4 1/2" H

DOOR PROFILE:

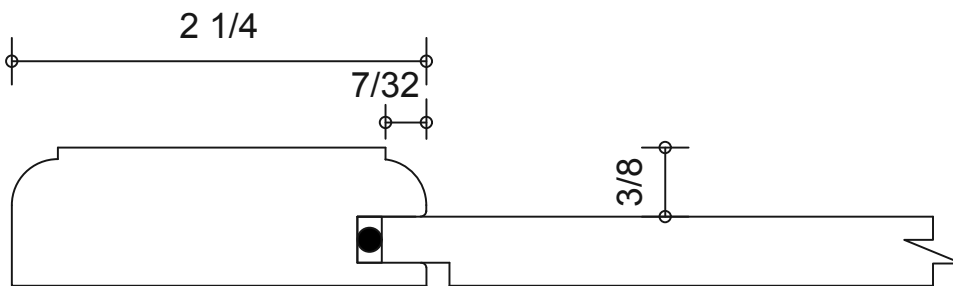

MULLION PROFILE:

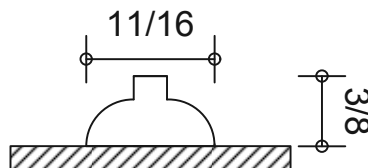

DOOR STYLES

BALSAM-3

Level One - Standard Door - No Upcharge

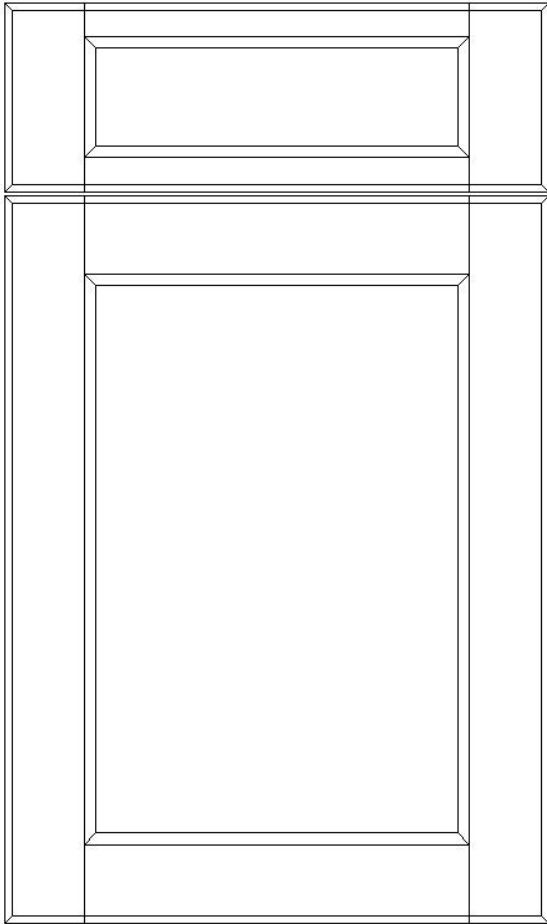

DOORS

Horizontal Rail Width:	3"
Vertical Rail Width:	3"
Door Frame Thickness:	3/4"
Panel Raise Profile:	Reversed 3/8" Panel
Inside Edge Profile:	Step Round
Overlay Outside Edge Profile:	Step Round
Inset Outside Edge Profile:	Square Eased
Minimum Size:	7 1/2" W x 7 1/2" H

*Single panel doors larger than 24" W x 48" H will not be guaranteed against warpage.

5-PC DRAWER FRONTS

Horizontal Rail Width:	1 1/2"
Vertical Rail Width:	3"
Drawer Frame Thickness:	3/4"
Panel Raise Profile:	Reversed 3/8" Panel
Inside Edge Profile:	Step Round
Overlay Outside Edge Profile:	Step Round
Inset Outside Edge Profile:	Square Eased
Minimum Size:	7 1/2" W X 4 1/2" H

DOOR PROFILE:

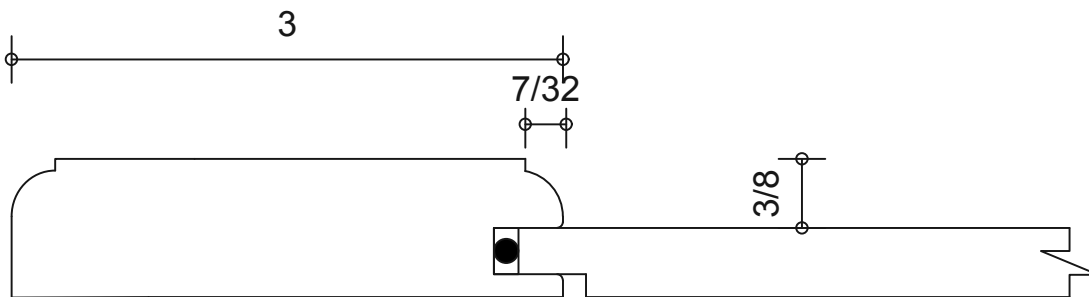

MULLION PROFILE:

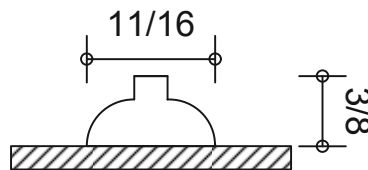

DOOR STYLES

BELVEDERE

Level One - Standard Door- No Upcharge

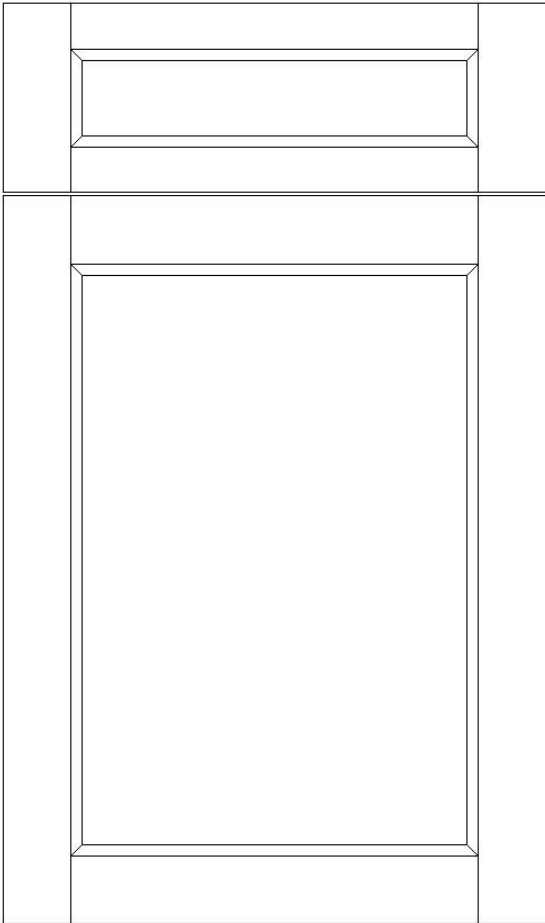

DOORS

Horizontal Rail Width:	2 1/4"
Vertical Rail Width:	2 1/4"
Door Frame Thickness:	3/4"
Panel Raise Profile:	Reversed 3/8" Panel
Inside Edge Profile:	Beveled
Overlay Outside Edge Profile:	Square Eased
Inset Outside Edge Profile:	Square Eased
Minimum Size:	6" W x 6" H

*Single panel doors larger than 24" W x 48" H will not be guaranteed against warpage.

5-PC DRAWER FRONTS

Horizontal Rail Width:	1 1/2"
Vertical Rail Width:	2 1/4"
Drawer Frame Thickness:	3/4"
Panel Raise Profile:	Reversed 3/8" Panel
Inside Edge Profile:	Beveled
Overlay Outside Edge Profile:	Square Eased
Inset Outside Edge Profile:	Square Eased
Minimum Size:	6" W X 4 1/2" H

DOOR PROFILE:

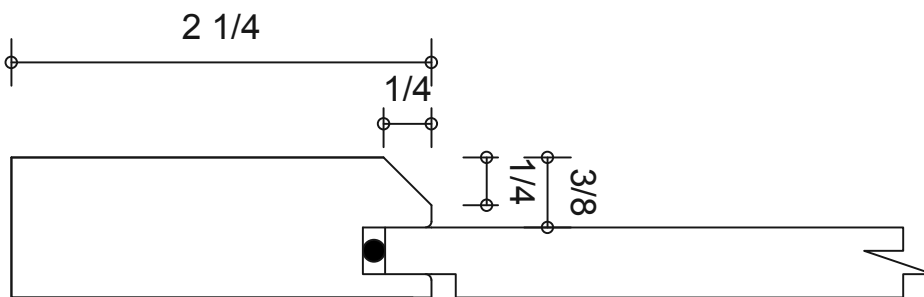

MULLION PROFILE:

DOOR STYLES

BELVEDERE-3

Level One - Standard Door- No Upcharge

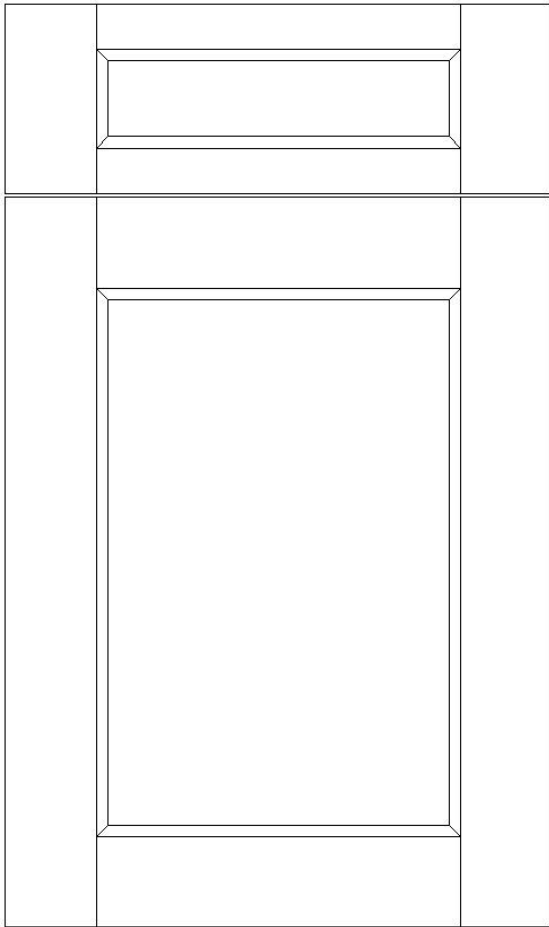

DOORS

Horizontal Rail Width:	3"
Vertical Rail Width:	3"
Door Frame Thickness:	3/4"
Panel Raise Profile:	Reversed 3/8" Panel
Inside Edge Profile:	Beveled
Overlay Outside Edge Profile:	Square Eased
Inset Outside Edge Profile:	Square Eased
Minimum Size:	7 1/2" W x 7 1/2" H

*Single panel doors larger than 24" W x 48" H will not be guaranteed against warpage.

5 PC DRAWER FRONTS

Horizontal Rail Width:	1 1/2"
Vertical Rail Width:	2 1/4"
Drawer Frame Thickness:	3/4"
Panel Raise Profile:	Reversed 3/8" Panel
Inside Edge Profile:	Beveled
Overlay Outside Edge Profile:	Square Eased
Inset Outside Edge Profile:	Square Eased
Minimum Size:	7 1/2" W X 4 1/2" H

DOOR PROFILE:

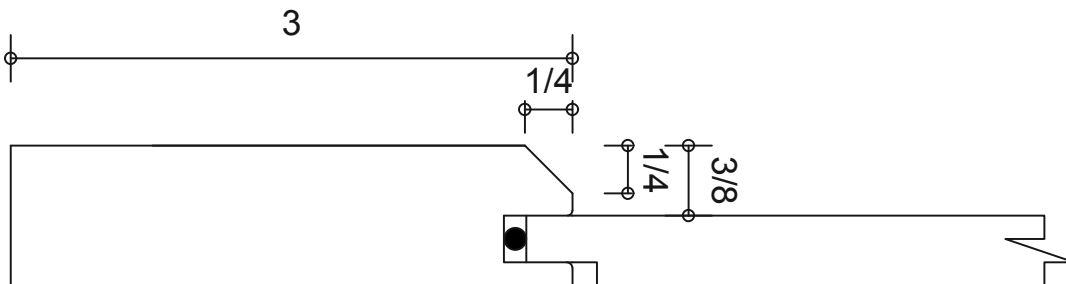

MULLION PROFILE:

DOOR STYLES

CARAVAL

Level One - Standard Door- No Upcharge

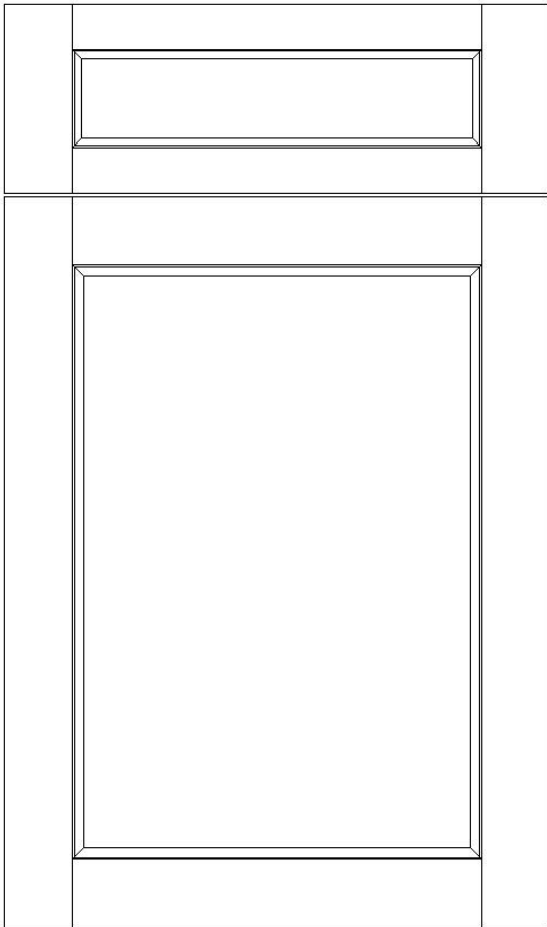

DOORS

Horizontal Rail Width:	2 1/4"
Vertical Rail Width:	2 1/4"
Door Frame Thickness:	3/4"
Panel Raise Profile:	Reversed 3/8" Panel
Inside Edge Profile:	Step Cove
Overlay Outside Edge Profile:	Square Eased
Inset Outside Edge Profile:	Square Eased
Minimum Size:	6" W x 6" H

*Single panel doors larger than 24" W x 48" H will not be guaranteed against warpage.

5-PC DRAWER FRONTS

Horizontal Rail Width:	1 1/2"
Vertical Rail Width:	2 1/4"
Drawer Frame Thickness:	3/4"
Panel Raise Profile:	Reversed 3/8" Panel
Inside Edge Profile:	Step Cove
Overlay Outside Edge Profile:	Square Eased
Inset Outside Edge Profile:	Square Eased
Minimum Size:	6" W x 4 1/2" H

DOOR PROFILE:

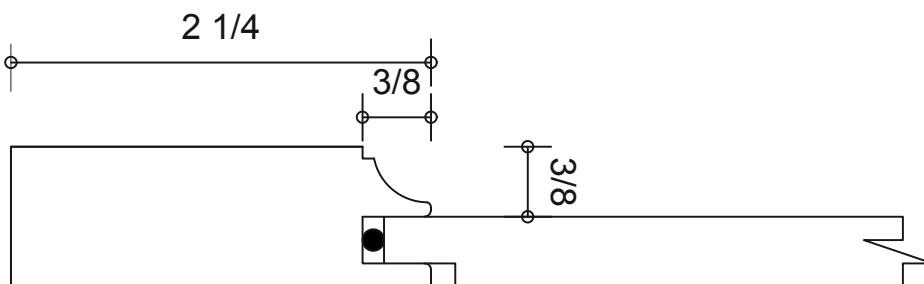

MULLION PROFILE:

DOOR STYLES

CARAVAL-3

Level One - Standard Door- No Upcharge

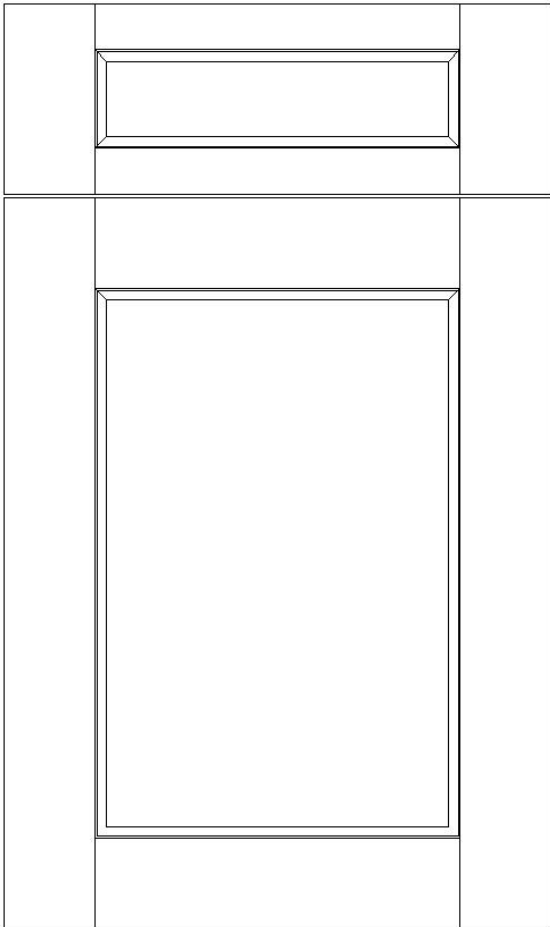

DOORS

Horizontal Rail Width:	3"
Vertical Rail Width:	3"
Door Frame Thickness:	3/4"
Panel Raise Profile:	Reversed 3/8" Panel
Inside Edge Profile:	Step Cove
Overlay Outside Edge Profile:	Square Eased
Inset Outside Edge Profile:	Square Eased
Minimum Size:	7 1/2" W x 7 1/2" H

*Single panel doors larger than 24" W x 48" H will not be guaranteed against warpage.

5-PC DRAWER FRONTS

Horizontal Rail Width:	1 1/2"
Vertical Rail Width:	3"
Drawer Frame Thickness:	3/4"
Panel Raise Profile:	Reversed 3/8" Panel
Inside Edge Profile:	Step Cove
Overlay Outside Edge Profile:	Square Eased
Inset Outside Edge Profile:	Square Eased
Minimum Size:	7 1/2" W x 4 1/2" H

DOOR PROFILE:

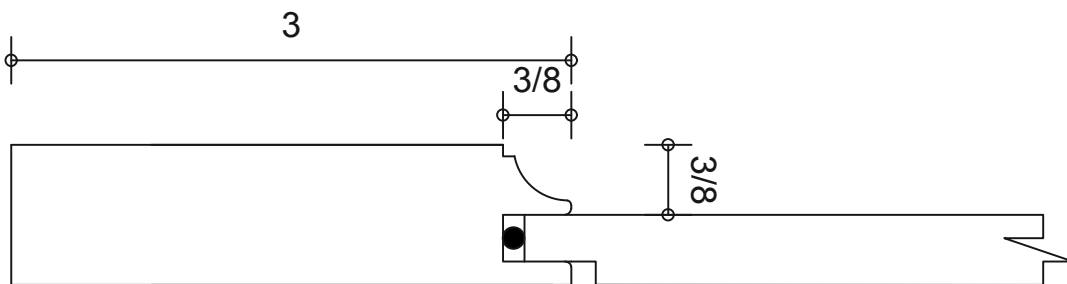

MULLION PROFILE:

DOOR STYLES

CARRINGTON

Level One - Standard Door- No Upcharge

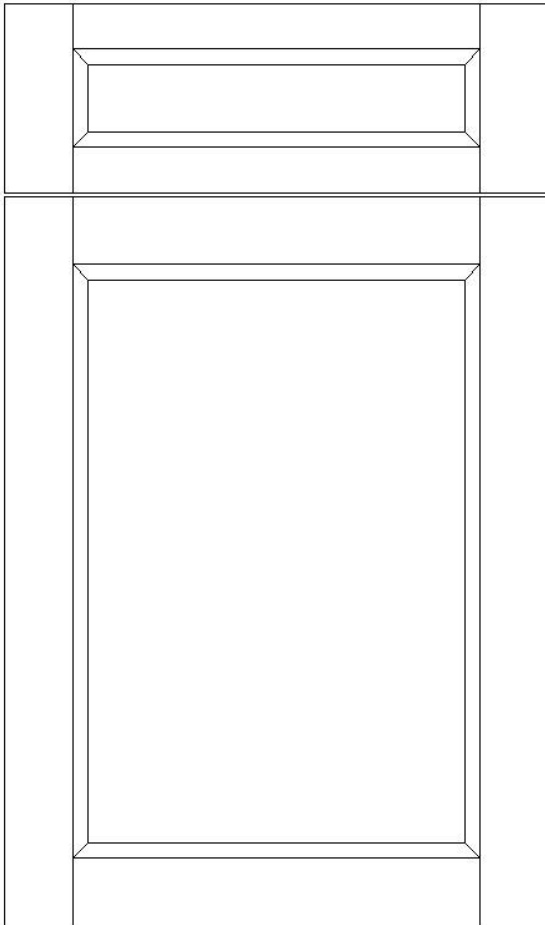

DOORS

Horizontal Rail Width:	2 1/4"
Vertical Rail Width:	2 1/4"
Door Frame Thickness:	3/4"
Panel Raise Profile:	Quarter Cove Panel
Inside Edge Profile:	Square
Overlay Outside Edge Profile:	Square Eased
Inset Outside Edge Profile:	Square Eased
Minimum Size:	6"W x 6" H

* Single panel doors larger than 24" W x 48" H will not be guaranteed against warpage.

5-PC DRAWER FRONTS

Horizontal Rail Width:	1 1/2"
Vertical Rail Width:	2 1/4"
Drawer Frame Thickness:	3/4"
Panel Raise Profile:	Quarter Cove Panel
Inside Edge Profile:	Square
Overlay Outside Edge Profile:	Square Eased
Inset Outside Edge Profile:	Square Eased
Minimum Size:	6" W x 4 1/2" H

DOOR PROFILE:

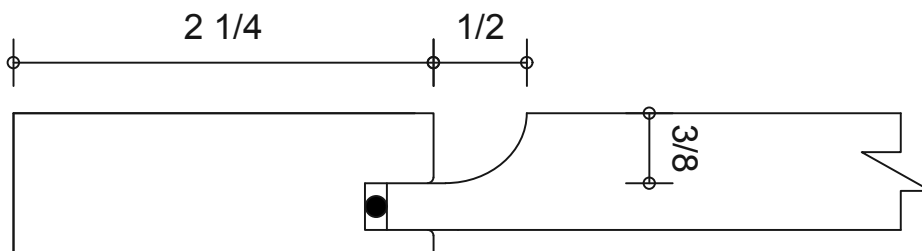

MULLION PROFILE:

DOOR STYLES

CARRINGTON-3

Level One - Standard Door- No Upcharge

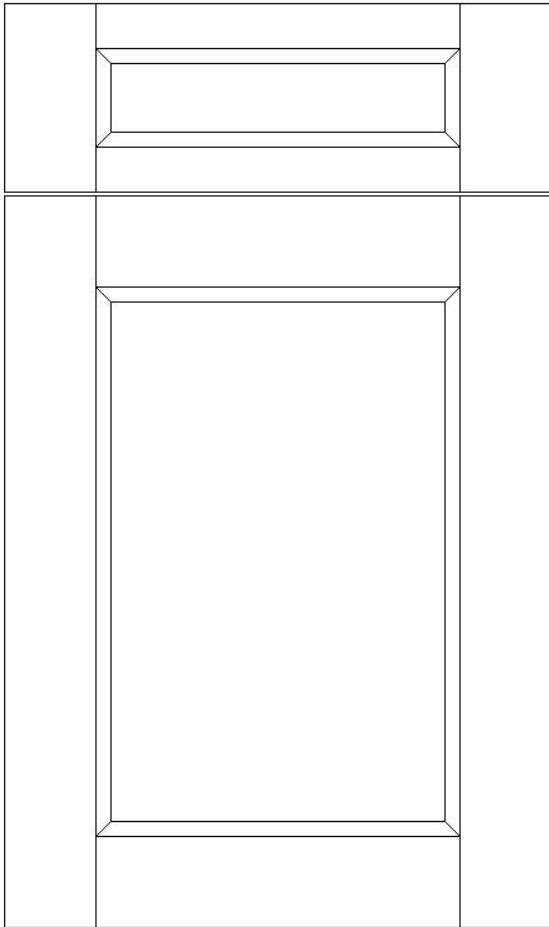

DOORS

Horizontal Rail Width:	3"
Vertical Rail Width:	3"
Door Frame Thickness:	3/4"
Panel Raise Profile:	Quarter Cove Panel
Inside Edge Profile:	Square
Overlay Outside Edge Profile:	Square Eased
Inset Outside Edge Profile:	Square Eased
Minimum Size:	7. 1/2" W x 7 1/2" H

* Single panel doors larger than 24" W x 48" H will not be guaranteed against warpage.

5-PC DRAWER FRONTS

Horizontal Rail Width:	1 1/2"
Vertical Rail Width:	2 1/4"
Drawer Frame Thickness:	3/4"
Panel Raise Profile:	Quarter Cove Panel
Inside Edge Profile:	Square
Overlay Outside Edge Profile:	Square Eased
Inset Outside Edge Profile:	Square Eased
Minimum Size:	7 1/2" W x 4 1/2" H

7.5

DOOR PROFILE:

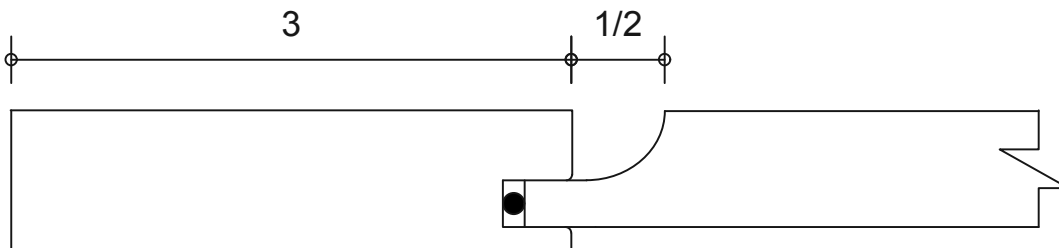

MULLION PROFILE:

DOOR STYLES

CHARLESTON

Level One - Standard Door- No Upcharge

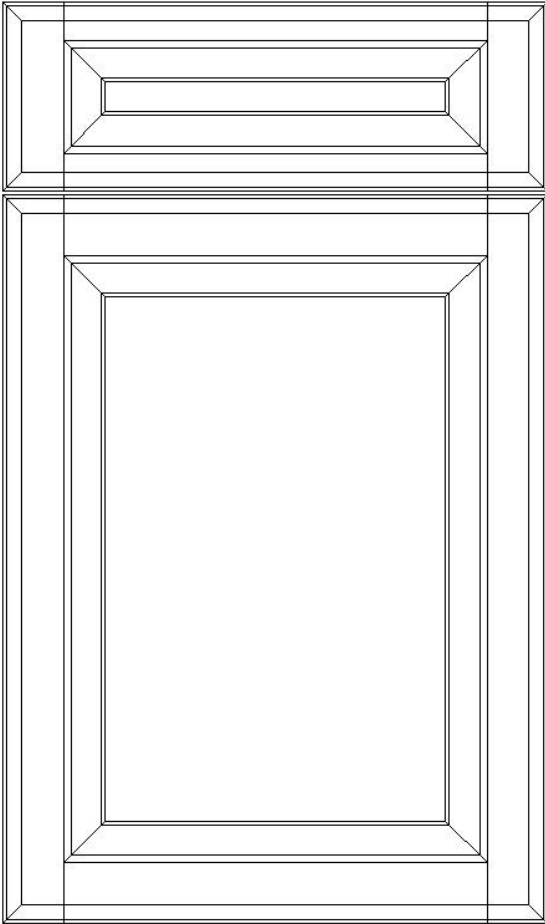

DOORS

Horizontal Rail Width:	2 1/4"
Vertical Rail Width:	2 1/4"
Door Frame Thickness:	3/4"
Panel Raise Profile:	Beaded Ogee
Inside Edge Profile:	Step Round
Overlay Outside Edge Profile:	Classical
Inset Outside Edge Profile:	Square Eased
Minimum Size:	7 3/4" W x 7 3/4" H

*Single panel doors larger than 24" W x 48" H will not be guaranteed against warpage.

5-PC DRAWER FRONTS

Horizontal Rail Width:	1 1/2"
Vertical Rail Width:	2 1/4"
Drawer Frame Thickness:	3/4"
Panel Raise Profile:	Beaded Ogee
Inside Edge Profile:	Step Round
Overlay Outside Edge Profile:	Classical
Inset Outside Edge Profile:	Square Eased
Minimum Size:	7 3/4" W x 6 1/4" H

DOOR PROFILE:

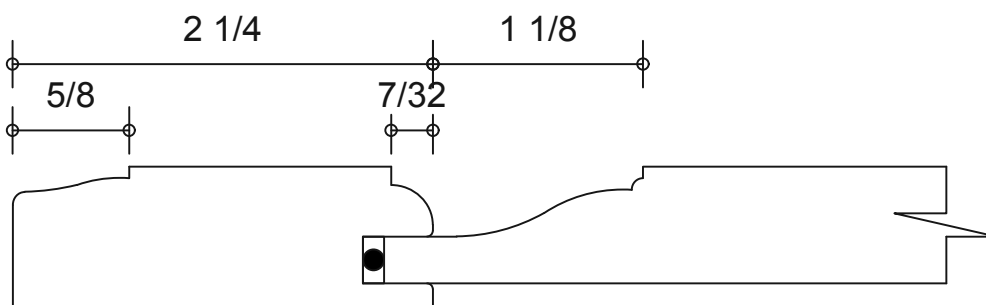

MULLION PROFILE:

DOOR STYLES

CHARLESTON-3

Level One - Standard Door- No Upcharge

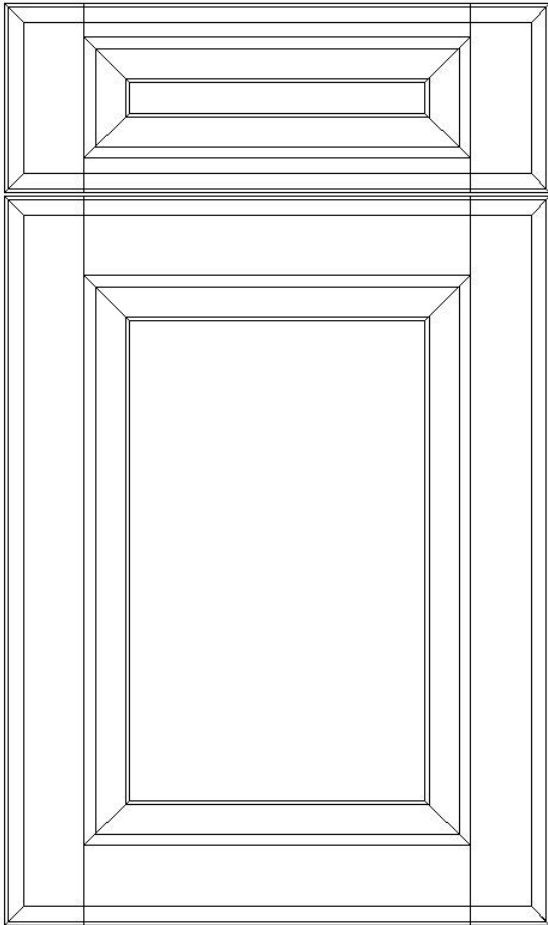

DOORS

Horizontal Rail Width:	3"
Vertical Rail Width:	3"
Door Frame Thickness:	3/4"
Panel Raise Profile:	Beaded Ogee
Inside Edge Profile:	Step Round
Overlay Outside Edge Profile:	Classical
Inset Outside Edge Profile:	Square Eased
Minimum Size:	9 1/4" W x 9 1/4" H

*Single panel doors larger than 24" W x 48" H will not be guaranteed against warpage.

5-PC DRAWER FRONTS

Horizontal Rail Width:	1 1/2"
Vertical Rail Width:	3"
Drawer Frame Thickness:	3/4"
Panel Raise Profile:	Beaded Ogee
Inside Edge Profile:	Step Round
Overlay Outside Edge Profile:	Classical
Inset Outside Edge Profile:	Square Eased
Minimum Size:	9 1/4" W x 6 1/4" H

DOOR PROFILE:

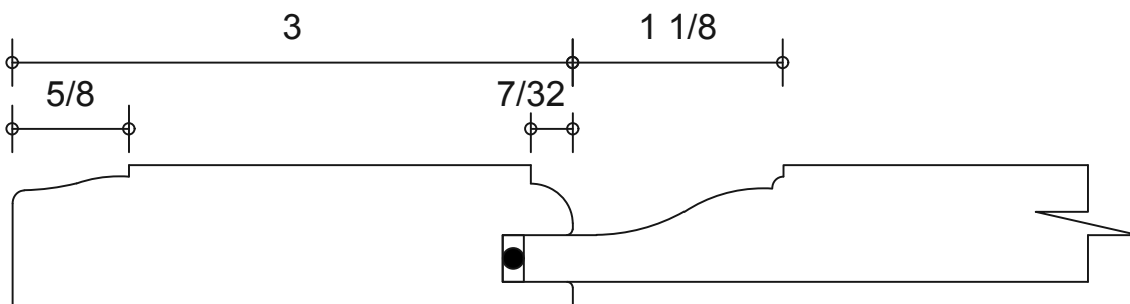

MULLION PROFILE:

DOOR STYLES

CONNESTEE

Level One - Standard Door- No Upcharge

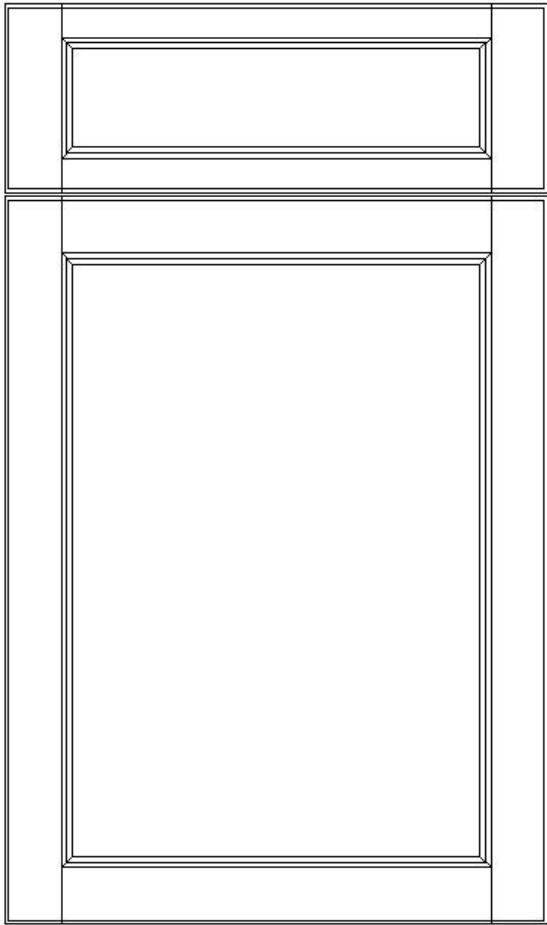

DOORS

Horizontal Rail Width:	2 1/4"
Vertical Rail Width:	2 1/4"
Door Frame Thickness:	3/4"
Panel Raise Profile:	Reversed 3/8" Panel
Inside Edge Profile:	Ogee
Overlay Outside Edge Profile:	1/8" Radius
Inset Outside Edge Profile:	Square Eased
Minimum Size:	6" W x 6" H

*Single panel doors larger than 24" W x 48" H will not be guaranteed against warpage.

5-PC DRAWER FRONTS

Horizontal Rail Width:	1 1/2"
Vertical Rail Width:	2 1/4"
Drawer Frame Thickness:	3/4"
Panel Raise Profile:	Reversed 3/8" Panel
Inside Edge Profile:	Ogee
Overlay Outside Edge Profile:	1/8" Radius
Inset Outside Edge Profile:	Square Eased
Minimum Size:	6" W x 4 1/2" H

DOOR PROFILE:

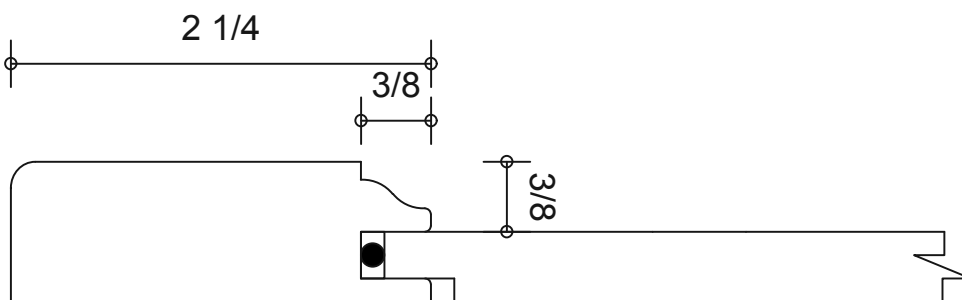

MULLION PROFILE:

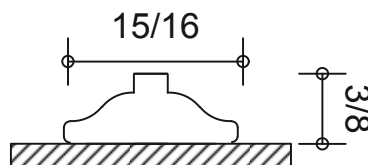

DOOR STYLES

CONNESTEE-3

Level One - Standard Door- No Upcharge

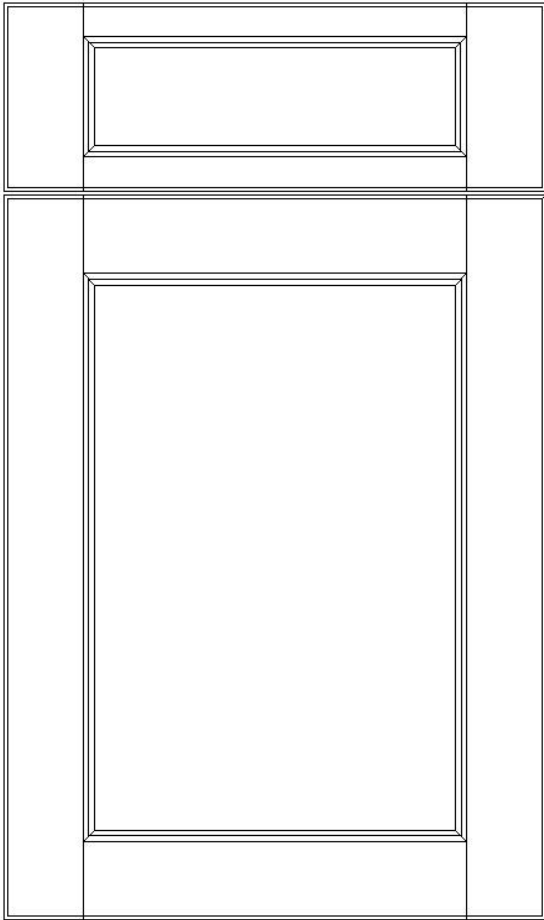

DOORS

Horizontal Rail Width:	3"
Vertical Rail Width:	3"
Door Frame Thickness:	3/4"
Panel Raise Profile:	Reversed 3/8" Panel
Inside Edge Profile:	Ogee
Overlay Outside Edge Profile:	1/8" Radius
Inset Outside Edge Profile:	Square Eased
Minimum Size:	7 1/2" W x 7 1/2" H

*Single panel doors larger than 24" W x 48" H will not be guaranteed against warpage.

5-PC DRAWER FRONTS

Horizontal Rail Width:	1 1/2"
Vertical Rail Width:	3"
Drawer Frame Thickness:	3/4"
Panel Raise Profile:	Reversed 3/8" Panel
Inside Edge Profile:	Ogee
Overlay Outside Edge Profile:	1/8" Radius
Inset Outside Edge Profile:	Square Eased
Minimum Size:	7 1/2" W x 4 1/2" H

DOOR PROFILE:

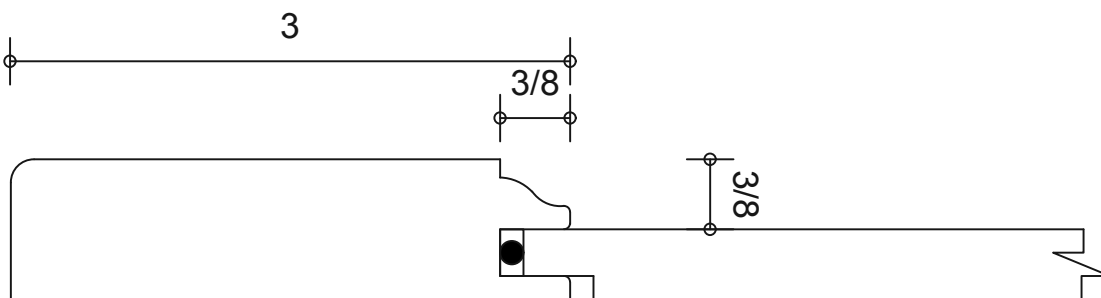

MULLION PROFILE:

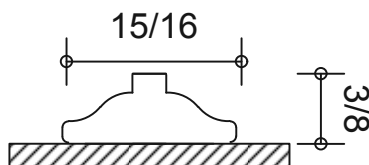

DOOR STYLES

DANIELTON

Level One - Standard Door- No Upcharge

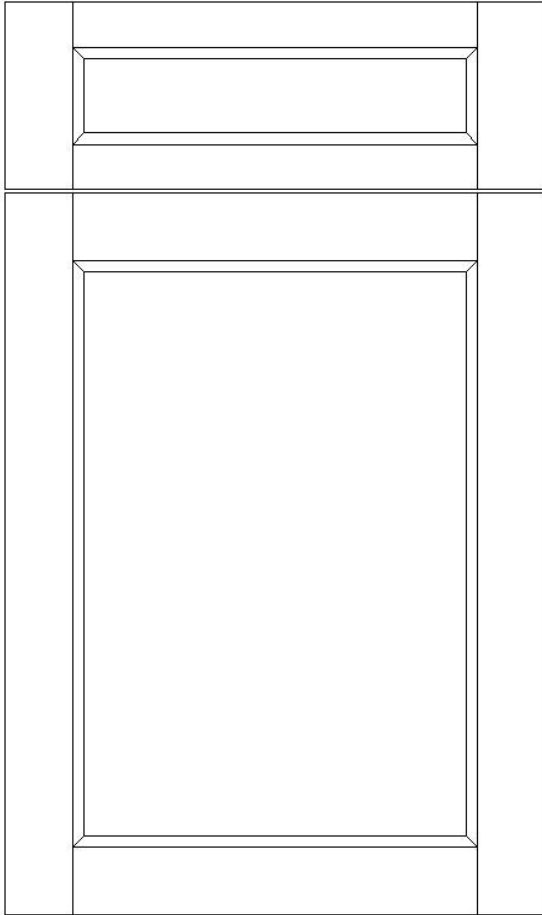

DOORS

Horizontal Rail Width:	2 1/4"
Vertical Rail Width:	2 1/4"
Door Frame Thickness:	3/4"
Panel Raise Profile:	Reversed 3/8" Panel
Inside Edge Profile:	Flat Bevel
Overlay Outside Edge Profile:	Square Eased
Inset Outside Edge Profile:	Square Eased
Minimum Size:	6" W x 6" H

*Single panel doors larger than 24" W x 48" H will not be guaranteed against warpage.

5-PC DRAWER FRONTS

Horizontal Rail Width:	1 1/2"
Vertical Rail Width:	2 1/4"
Drawer Frame Thickness:	3/4"
Panel Raise Profile:	Reversed 3/8" Panel
Inside Edge Profile:	Flat Bevel
Overlay Outside Edge Profile:	Square Eased
Inset Outside Edge Profile:	Square Eased
Minimum Size:	6" W x 4 1/2" H

DOOR PROFILE:

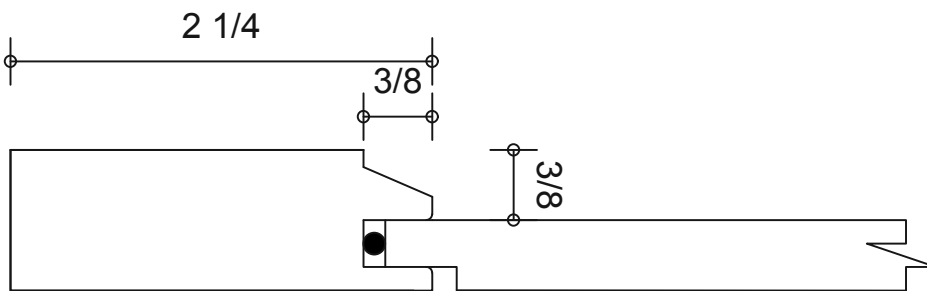

MULLION PROFILE:

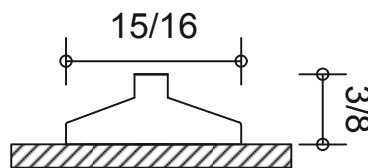

DOOR STYLES

DANIELTON-3

Level One - Standard Door- No Upcharge

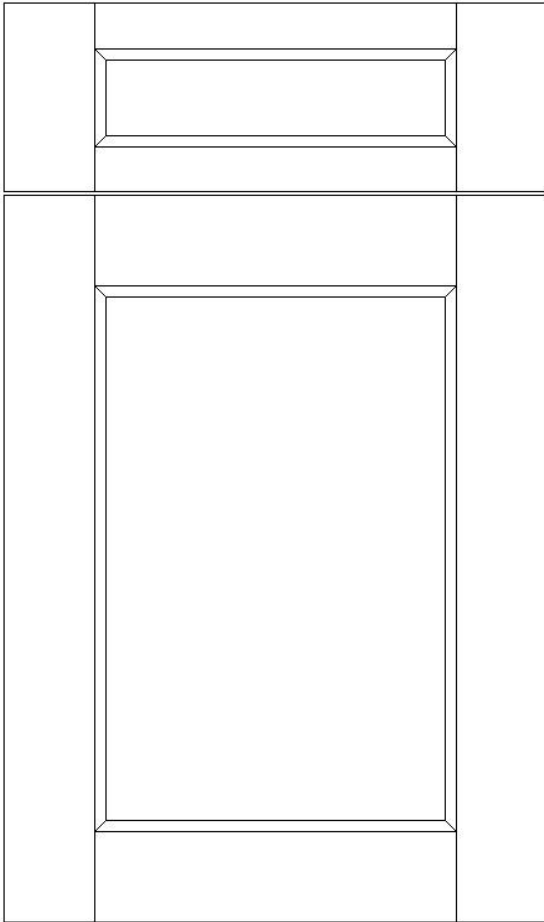

DOORS

Horizontal Rail Width:	3"
Vertical Rail Width:	3"
Door Frame Thickness:	3/4"
Panel Raise Profile:	Reversed 3/8" Panel
Inside Edge Profile:	Flat Bevel
Overlay Outside Edge Profile:	Square Eased
Inset Outside Edge Profile:	Square Eased
Minimum Size:	7 1/2" W x 7 1/2" H

*Single panel doors larger than 24" W x 48" H will not be guaranteed against warpage.

5-PC DRAWER FRONTS

Horizontal Rail Width:	1 1/2"
Vertical Rail Width:	3"
Drawer Frame Thickness:	3/4"
Panel Raise Profile:	Reversed 3/8" Panel
Inside Edge Profile:	Flat Bevel
Overlay Outside Edge Profile:	Square Eased
Inset Outside Edge Profile:	Square Eased
Minimum Size:	7 1/2" W x 4 1/2" H

DOOR PROFILE:

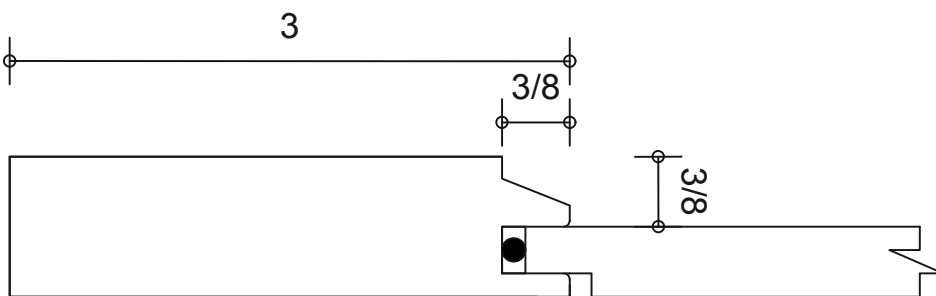

MULLION PROFILE:

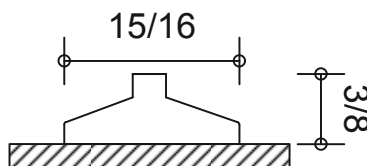

DOOR STYLES

DEVONSHIRE

Level One - Standard Door- No Upcharge

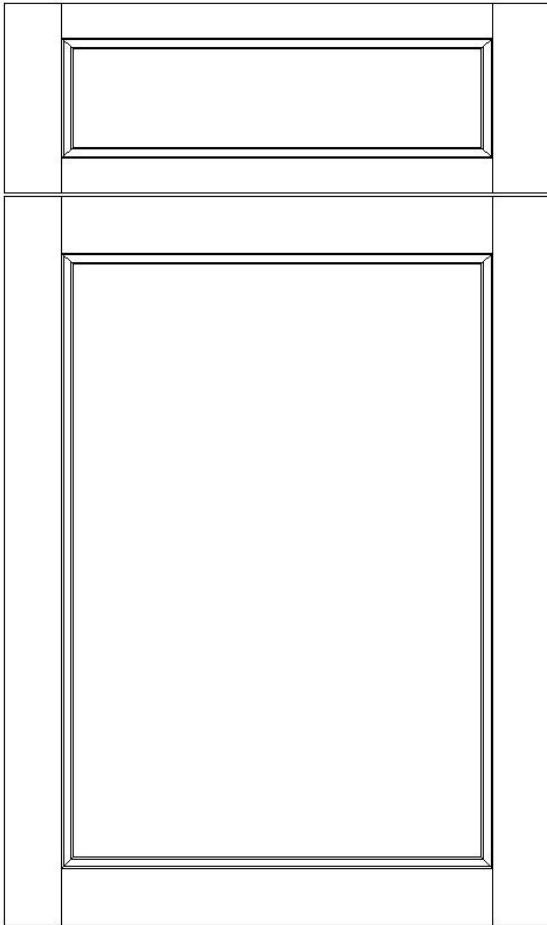

DOORS

Horizontal Rail Width:	2 1/4"
Vertical Rail Width:	2 1/4"
Door Frame Thickness:	3/4"
Panel Raise Profile:	Reversed 3/8" Panel
Inside Edge Profile:	Step Cove Step
Overlay Outside Edge Profile:	Square Eased
Inset Outside Edge Profile:	Square Eased
Minimum Size:	6" W x 6" H

*Single panel doors larger than 24" W x 48" H will not be guaranteed against warpage.

5-PC DRAWER FRONTS

Horizontal Rail Width:	1 1/2"
Vertical Rail Width:	2 1/4"
Drawer Frame Thickness:	3/4"
Panel Raise Profile:	Reversed 3/8" Panel
Inside Edge Profile:	Step Cove Step
Overlay Outside Edge Profile:	Square Eased
Inset Outside Edge Profile:	Square Eased
Minimum Size:	6" W x 4 1/2" H

DOOR PROFILE:

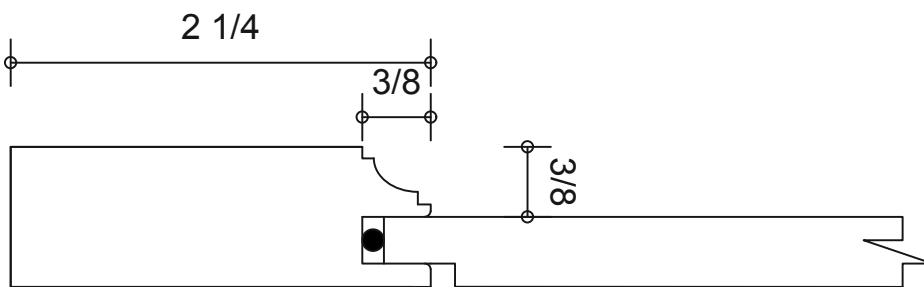

MULLION PROFILE:

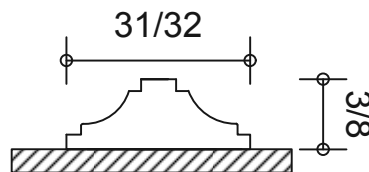

DOOR STYLES

DEVONSHIRE-3

Level One - Standard Door- No Upcharge

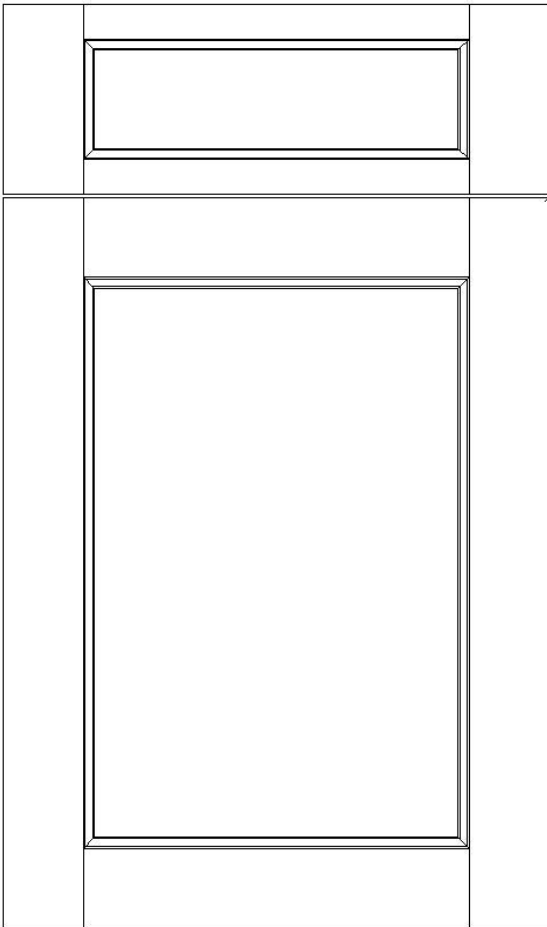

DOORS

Horizontal Rail Width:	3"
Vertical Rail Width:	3"
Door Frame Thickness:	3/4"
Panel Raise Profile:	Reversed 3/8" Panel
Inside Edge Profile:	Step Cove Step
Overlay Outside Edge Profile:	Square Eased
Inset Outside Edge Profile:	Square Eased
Minimum Size:	7 1/2" W x 7 1/2" H

*Single panel doors larger than 24" W x 48" H will not be guaranteed against warpage.

5-PC DRAWER FRONTS

Horizontal Rail Width:	1 1/2"
Vertical Rail Width:	3"
Drawer Frame Thickness:	3/4"
Panel Raise Profile:	Reversed 3/8" Panel
Inside Edge Profile:	Step Cove Step
Overlay Outside Edge Profile:	Square Eased
Inset Outside Edge Profile:	Square Eased
Minimum Size:	7 1/2" W x 4 1/2" H

DOOR PROFILE:

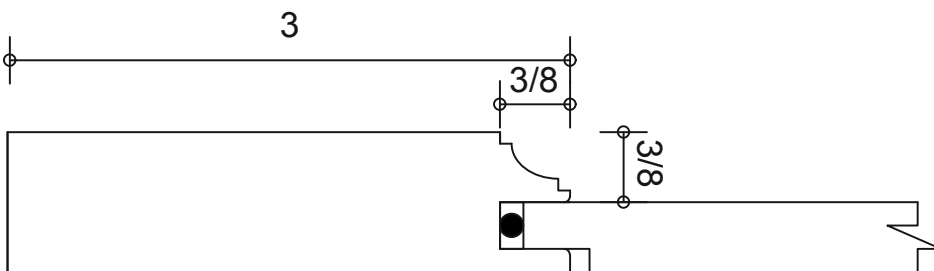

MULLION PROFILE:

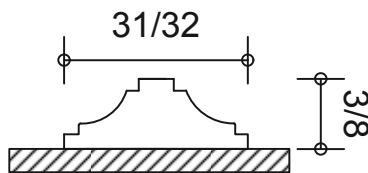

ELLESMERE

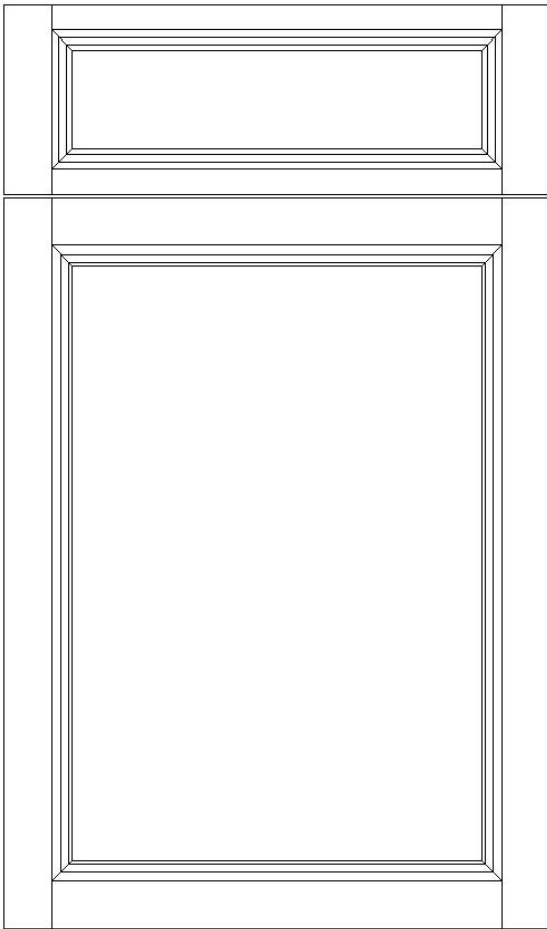

**NOT AVAILABLE IN DOORS
& DRAWERS WITH 2 1/4"
WIDE FRAME DUE TO
DRAWER BOX MOUNTING
ISSUES.**

DOOR STYLES

ELLESMERE-3

Level One - Standard Door- No Upcharge

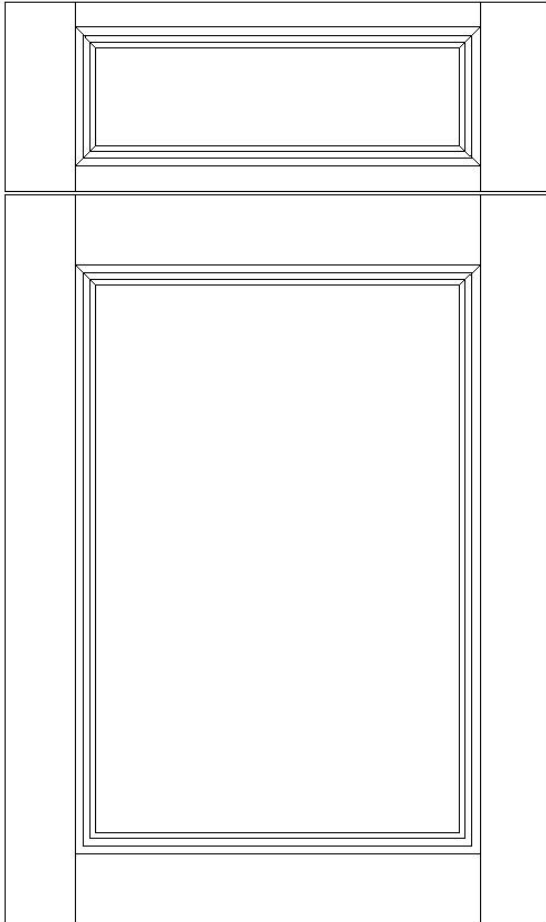

DOORS

Horizontal Rail Width:	3"
Vertical Rail Width:	3"
Door Frame Thickness:	3/4"
Panel Raise Profile:	Reversed Raised Panel
Inside Edge Profile:	Wide Ogee
Overlay Outside Edge Profile:	Square Eased
Inset Outside Edge Profile:	Square Eased
Minimum Size:	9 1/4" W x 9 1/4" H

*Single panel doors larger than 24" W x 48" H will not be guaranteed against warpage.

5-PC DRAWER FRONTS

Horizontal Rail Width:	1 1/2"
Vertical Rail Width:	3"
Drawer Frame Thickness:	3/4"
Panel Raise Profile:	Reversed Raised Panel
Inside Edge Profile:	Wide Ogee
Overlay Outside Edge Profile:	Square Eased
Inset Outside Edge Profile:	Square Eased

Minimum Size: 9 1/4" W x 6 1/4" H

DOOR PROFILE:

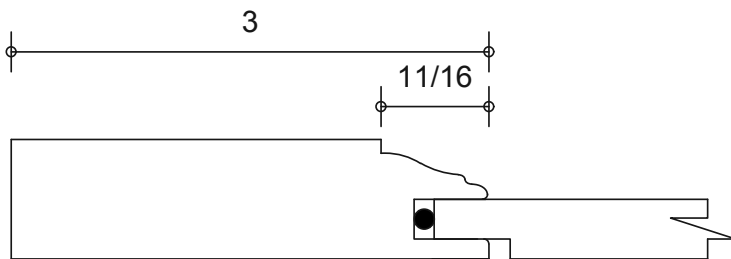

MULLION PROFILE:

Mullion Doors Not Available In This Profile

DOOR STYLES

KEOWEE

Level One - Standard Door- No Upcharge

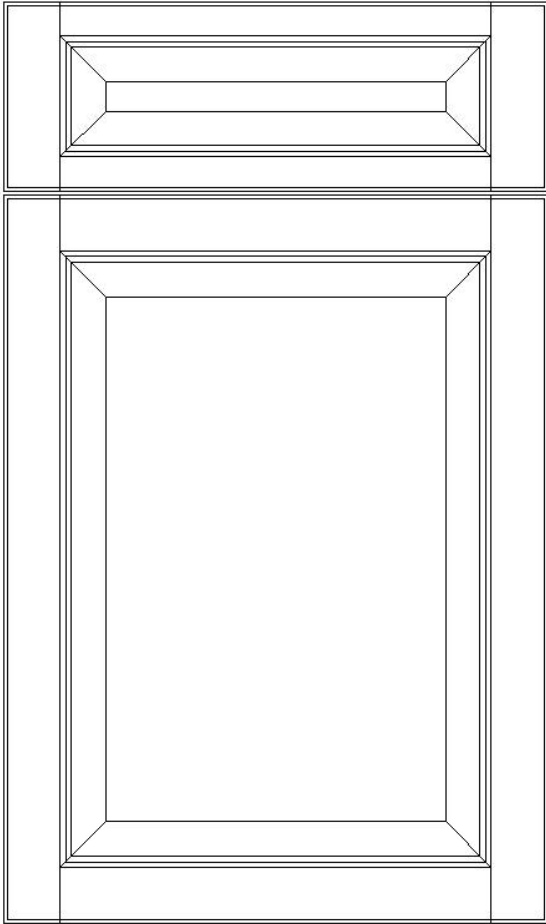

DOORS

Horizontal Rail Width:	2 1/4"
Vertical Rail Width:	2 1/4"
Door Frame Thickness:	3/4"
Panel Raise Profile:	Cove
Inside Edge Profile:	Ogee
Overlay Outside Edge Profile:	1/8" Radius
Inset Outside Edge Profile:	Square Eased
Minimum Size:	7 3/4" W x 7 3/4" H

*Single panel doors larger than 24" W x 48" H will not be guaranteed against warpage.

5-PC DRAWER FRONTS

Horizontal Rail Width:	1 1/2"
Vertical Rail Width:	2 1/4"
Drawer Frame Thickness:	3/4"
Panel Raise Profile:	Cove
Inside Edge Profile:	Ogee
Overlay Outside Edge Profile:	1/8" Radius
Inset Outside Edge Profile:	Square Eased
Minimum Size:	7 3/4" W x 6 1/4" H

DOOR PROFILE:

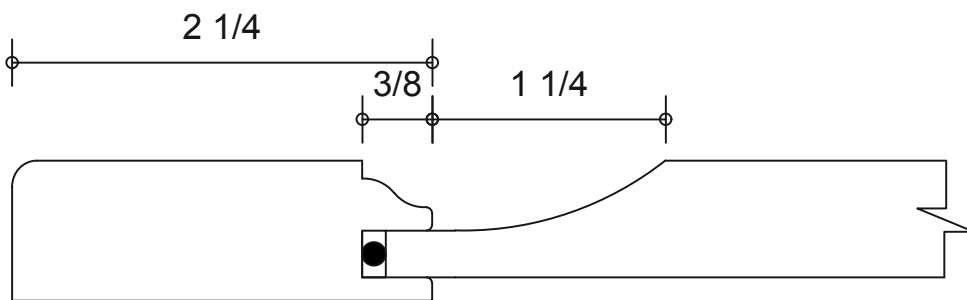

MULLION PROFILE:

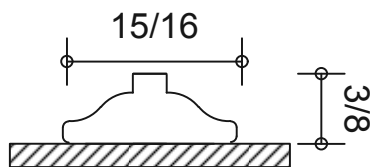

DOOR STYLES

KEOWEE-3

Level One - Standard Door- No Upcharge

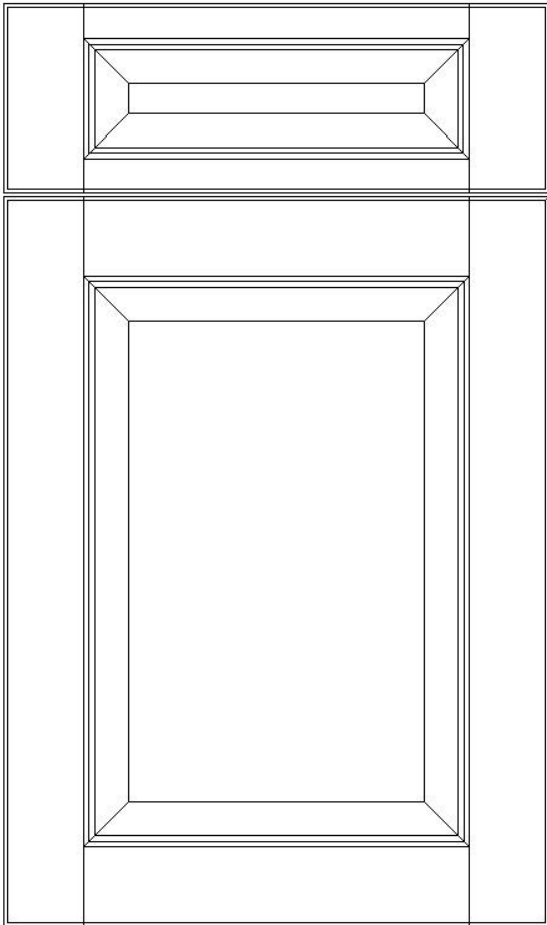

DOORS

Horizontal Rail Width:	3"
Vertical Rail Width:	3"
Door Frame Thickness:	3/4"
Panel Raise Profile:	Cove
Inside Edge Profile:	Ogee
Overlay Outside Edge Profile:	1/8" Radius
Inset Outside Edge Profile:	Square Eased
Minimum Size:	9 1/2" W x 9 1/2" H

*Single panel doors larger than 24" W x 48" H will not be guaranteed against warpage.

5-PC DRAWER FRONTS

Horizontal Rail Width:	1 1/2"
Vertical Rail Width:	3"
Drawer Frame Thickness:	3/4"
Panel Raise Profile:	Cove
Inside Edge Profile:	Ogee
Overlay Outside Edge Profile:	1/8" Radius
Inset Outside Edge Profile:	Square Eased
Minimum Size:	9 1/2" W x 7 3/4" H

DOOR PROFILE:

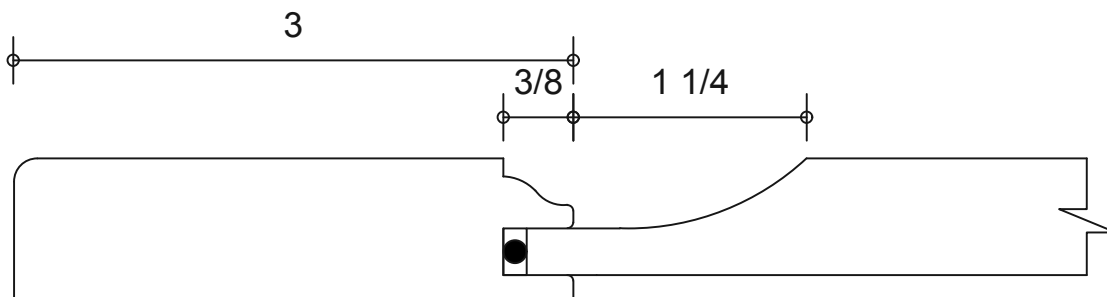

MULLION PROFILE:

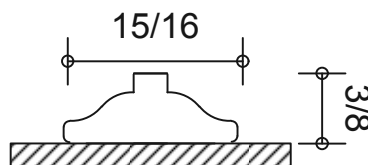

DOOR STYLES

MACINTOSH

Level One - Standard Door- No Upcharge

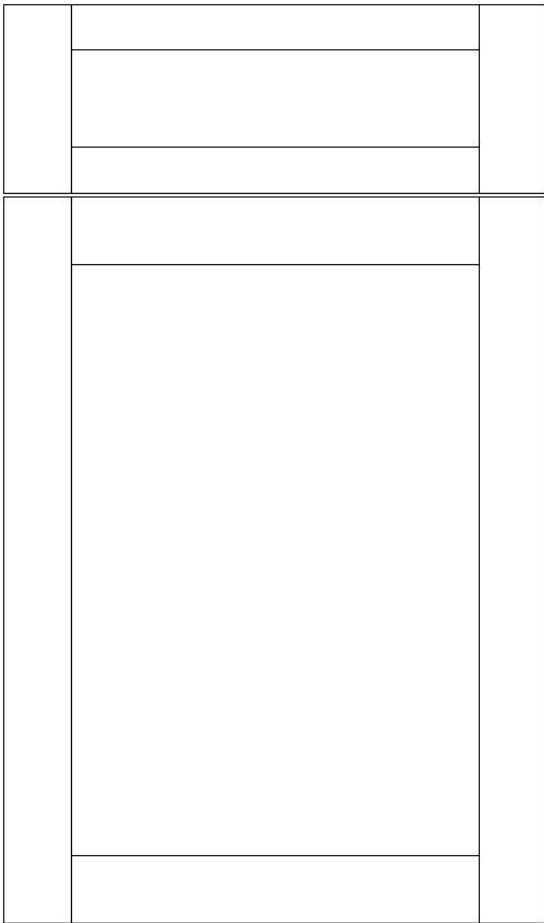

DOORS

Horizontal Rail Width:	2 1/4"
Vertical Rail Width:	2 1/4"
Door Frame Thickness:	3/4"
Panel Raise Profile:	Reversed 3/8" Panel
Inside Edge Profile:	Square
Overlay Outside Edge Profile:	Square Eased
Inset Outside Edge Profile:	Square Eased
Minimum Size:	6" W x 6" H

*Single panel doors larger than 24" W x 48" H will not be guaranteed against warpage.

5-PC DRAWER FRONTS

Horizontal Rail Width:	1 1/2"
Vertical Rail Width:	2 1/4"
Drawer Frame Thickness:	3/4"
Panel Raise Profile:	Reversed 3/8" Panel
Inside Edge Profile:	Square
Overlay Outside Edge Profile:	Square Eased
Inset Outside Edge Profile:	Square Eased
Minimum Size:	6" W x 4 1/2" H

DOOR PROFILE:

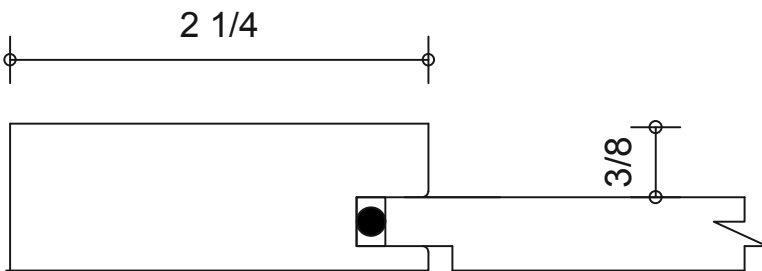

MULLION PROFILE:

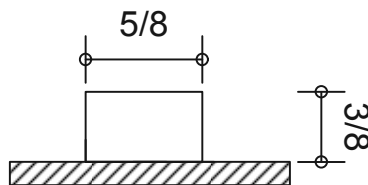

DOOR STYLES

MACINTOSH-3

Level One - Standard Door- No Upcharge

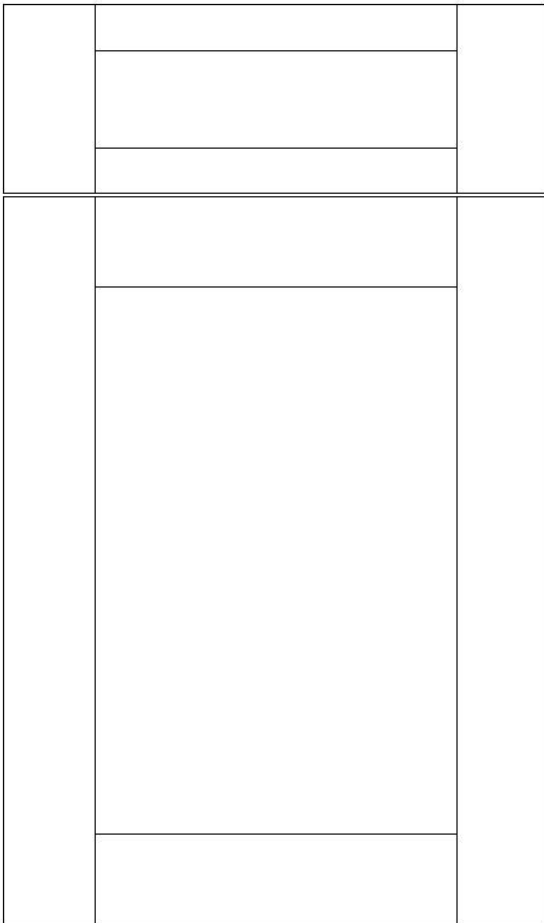

DOORS

Horizontal Rail Width:	3"
Vertical Rail Width:	3"
Door Frame Thickness:	3/4"
Panel Raise Profile:	Reversed 3/8" Panel
Inside Edge Profile:	Square
Overlay Outside Edge Profile:	Square Eased
Inset Outside Edge Profile:	Square Eased
Minimum Size:	7 1/2" W x 7 1/2" H

*Single panel doors larger than 24" W x 48" H will not be guaranteed against warpage.

5-PC DRAWER FRONTS

Horizontal Rail Width:	1 1/2"
Vertical Rail Width:	3"
Drawer Frame Thickness:	3/4"
Panel Raise Profile:	Reversed 3/8" Panel
Inside Edge Profile:	Square
Overlay Outside Edge Profile:	Square Eased
Inset Outside Edge Profile:	Square Eased
Minimum Size:	7 1/2" W x 4 1/2" H

DOOR PROFILE:

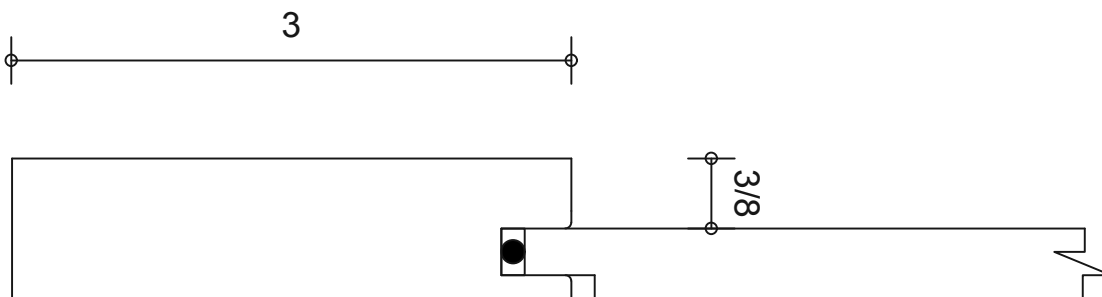

MULLION PROFILE:

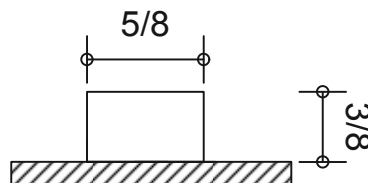

DOOR STYLES

ROSSINGTON

Level One - Standard Door- No Upcharge

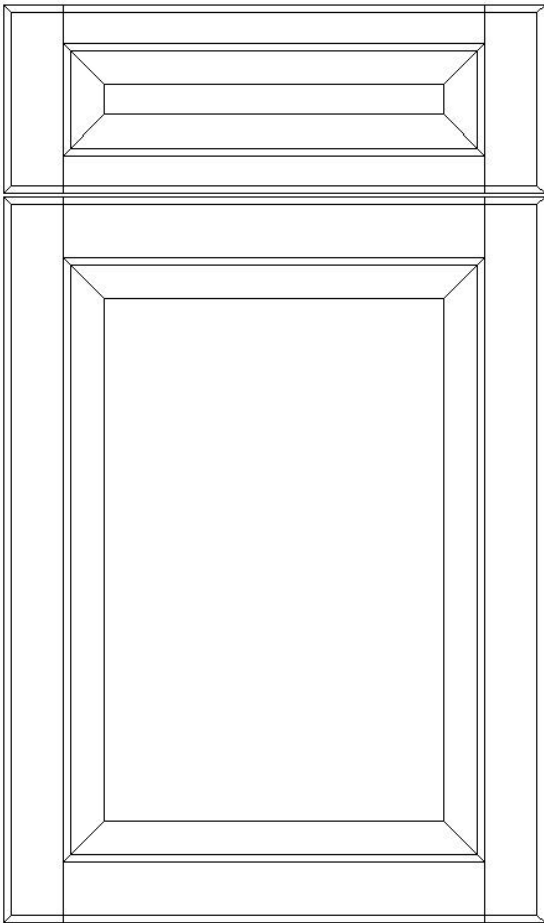

DOORS

Horizontal Rail Width:	2 1/4"
Vertical Rail Width:	2 1/4"
Door Frame Thickness:	3/4"
Panel Raise Profile:	Ogee
Inside Edge Profile:	Ogee
Overlay Outside Edge Profile:	Roman
Inset Outside Edge Profile:	Square Eased
Minimum Size:	8" W x 8" H

*Single panel doors larger than 24" W x 48" H will not be guaranteed against warpage.

5-PC DRAWER FRONTS

Horizontal Rail Width:	1 1/2"
Vertical Rail Width:	2 1/4"
Drawer Frame Thickness:	3/4"
Panel Raise Profile:	Ogee
Inside Edge Profile:	Ogee
Overlay Outside Edge Profile:	Roman
Inset Outside Edge Profile:	Square Eased
Minimum Size:	8" W x 6 1/2"

DOOR PROFILE:

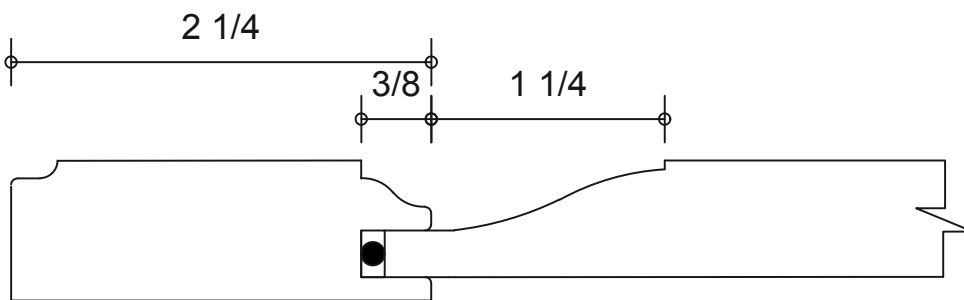

MULLION PROFILE:

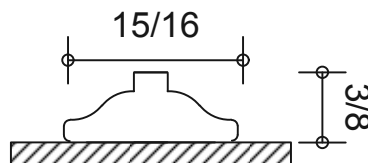

DOOR STYLES

ROSSINGTON-3

Level One - Standard Door- No Upcharge

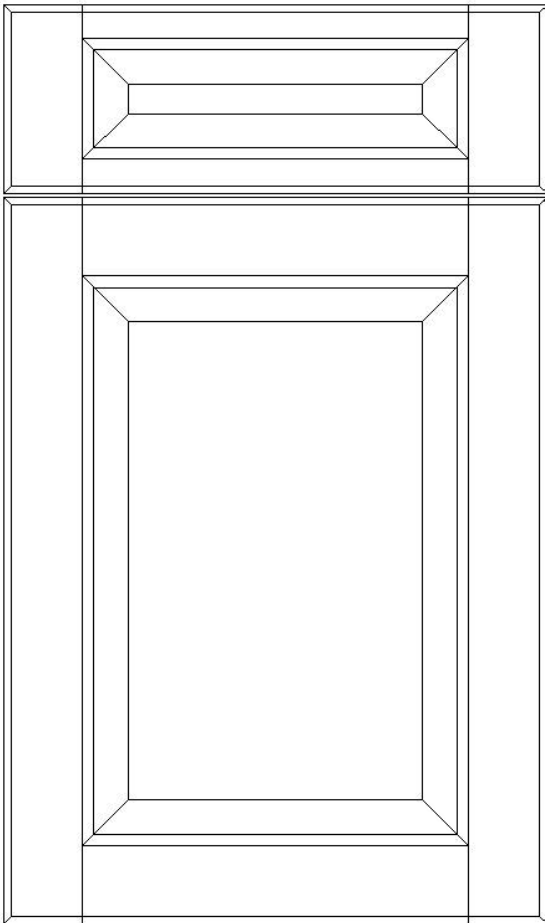

DOORS

Horizontal Rail Width:	3"
Vertical Rail Width:	3"
Door Frame Thickness:	3/4"
Panel Raise Profile:	Ogee
Inside Edge Profile:	Ogee
Overlay Outside Edge Profile:	Roman
Inset Outside Edge Profile:	Square Eased
Minimum Size:	9 1/2" W x 9 1/2" H

*Single panel doors larger than 24" W x 48" H will not be guaranteed against warpage.

5-PC DRAWER FRONTS

Horizontal Rail Width:	1 1/2"
Vertical Rail Width:	3"
Drawer Frame Thickness:	3/4"
Panel Raise Profile:	Ogee
Inside Edge Profile:	Ogee
Overlay Outside Edge Profile:	Roman
Inset Outside Edge Profile:	Square Eased
Minimum Size:	9 1/2" W x 6 1/2"

DOOR PROFILE:

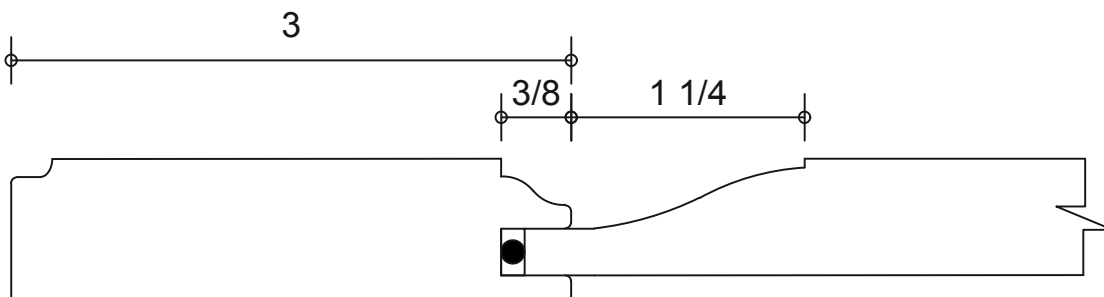

MULLION PROFILE:

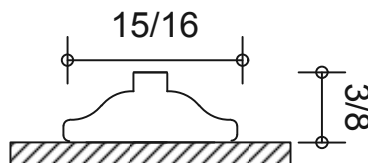

DOOR STYLES

STANTON

Level One - Standard Door- No Upcharge

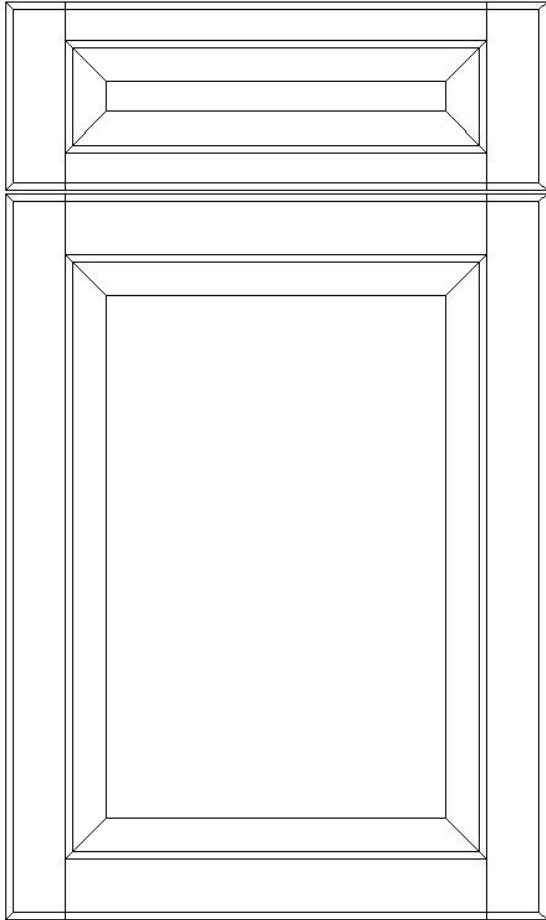

DOORS

Horizontal Rail Width:	2 1/4"
Vertical Rail Width:	2 1/4"
Door Frame Thickness:	3/4"
Panel Raise Profile:	Slant
Inside Edge Profile:	Step Round
Overlay Outside Edge Profile:	Step Round
Inset Outside Edge Profile:	Square Eased
Minimum Size:	7 3/4" W x 7 3/4" H

*Single panel doors larger than 24" W x 48" H will not be guaranteed against warpage.

5-PC DRAWER FRONTS

Horizontal Rail Width:	1 1/2"
Vertical Rail Width:	2 1/4"
Drawer Frame Thickness:	3/4"
Panel Raise Profile:	Slant
Inside Edge Profile:	Step Round
Overlay Outside Edge Profile:	Step Round
Inset Outside Edge Profile:	Square Eased
Minimum Size:	7 3/4" W x 6 1/4" H

DOOR PROFILE:

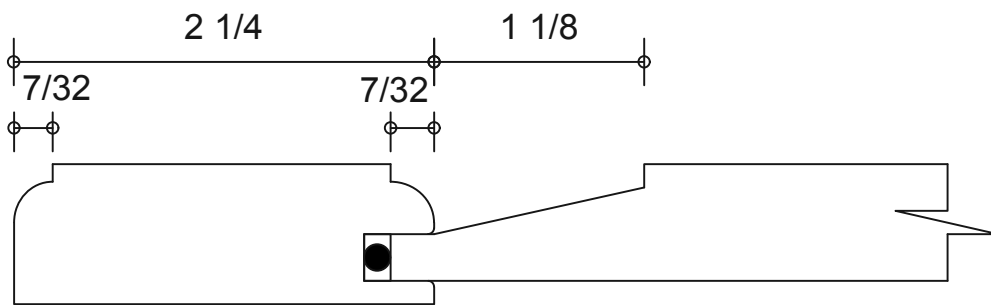

MULLION PROFILE:

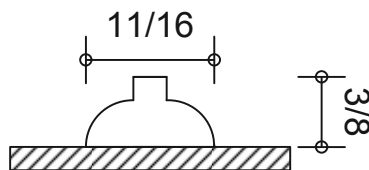

DOOR STYLES

STANTON-3

Level One - Standard Door- No Upcharge

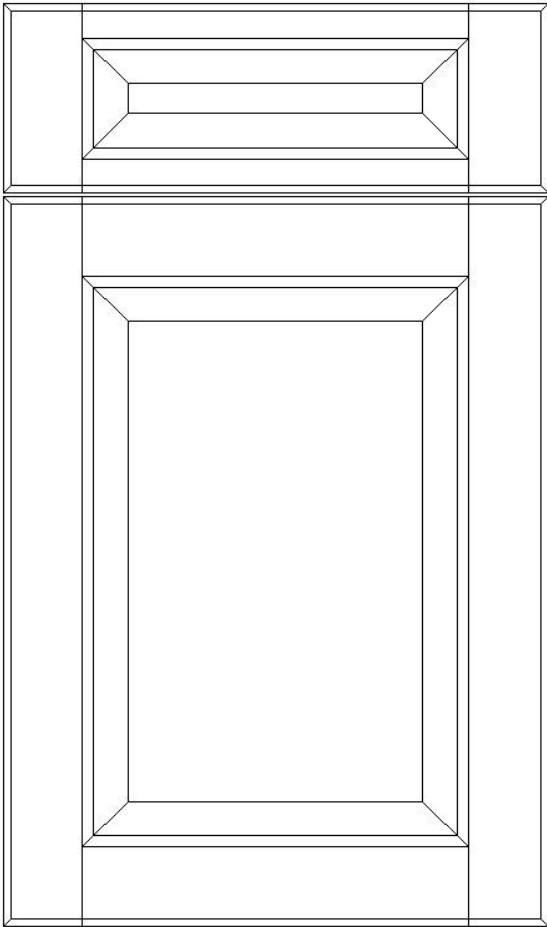

DOORS

Horizontal Rail Width:	3"
Vertical Rail Width:	3"
Door Frame Thickness:	3/4"
Panel Raise Profile:	Slant
Inside Edge Profile:	Step Round
Overlay Outside Edge Profile:	Step Round
Inset Outside Edge Profile:	Square Eased
Minimum Size:	9 1/4" W x 9 1/4" H

*Single panel doors larger than 24" W x 48" H will not be guaranteed against warpage.

5-PC DRAWER FRONTS

Horizontal Rail Width:	1 1/2"
Vertical Rail Width:	2 1/4"
Drawer Frame Thickness:	3/4"
Panel Raise Profile:	Slant
Inside Edge Profile:	Step Round
Overlay Outside Edge Profile:	Step Round
Inset Outside Edge Profile:	Square Eased
Minimum Size:	9 1/4" W x 6 1/4" H

DOOR PROFILE:

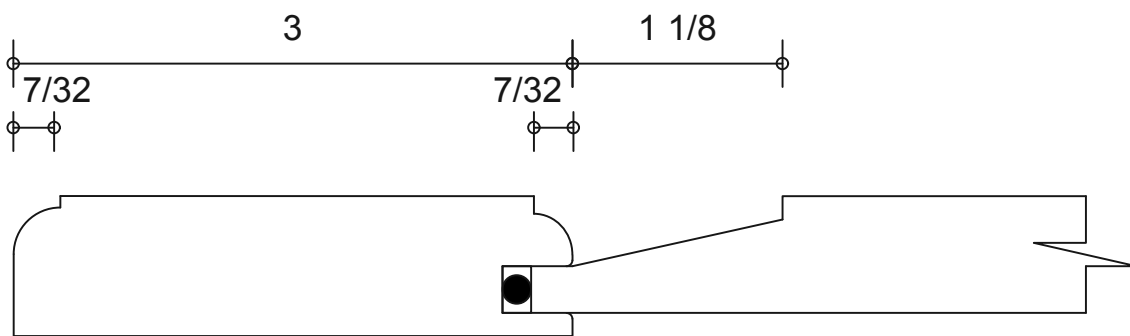

MULLION PROFILE:

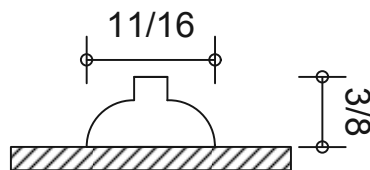

DOOR STYLES

BAILEY

Level Two - Applied Molding Door
Add \$84 Per Door/Drawer Front

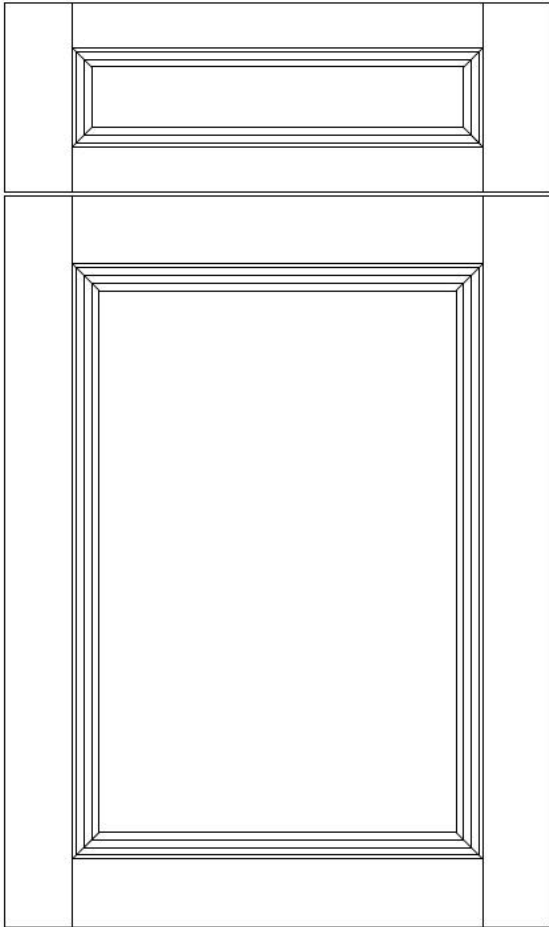

DOORS

Horizontal Rail Width:	2 1/4"
Vertical Rail Width:	2 1/4"
Door Frame Thickness:	3/4"
Panel Raise Profile:	Reversed 3/8" Panel
Inside Edge Profile:	AM3 Applied Molding
Overlay Outside Edge Profile:	Square Eased
Inset Outside Edge Profile:	Square Eased
Minimum Size:	7 7/8" W x 7 7/8" H

* Single panel doors larger than 24" W x 48" H will not be guaranteed against warpage.

5-PC DRAWER FRONTS

Horizontal Rail Width:	1 1/2"
Vertical Rail Width:	2 1/4"
Drawer Frame Thickness:	3/4"
Panel Raise Profile:	Reversed 3/8" Panel
Inside Edge Profile:	AM3 Applied Molding
Overlay Outside Edge Profile:	Square Eased
Inset Outside Edge Profile:	Square Eased
Minimum Size:	7 7/8" W x 6 3/8" H

DOOR PROFILE:

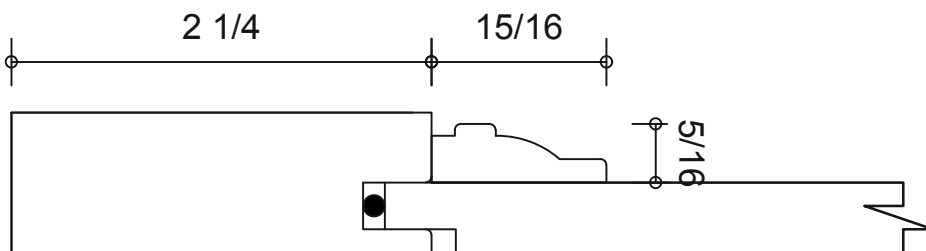

MULLION PROFILE:

Matching Mullion Doors Not Available In This Door Style.

DOOR STYLES

BAILEY-3

Level Two - Applied Molding Door
Add \$84 Per Door/Drawer Front

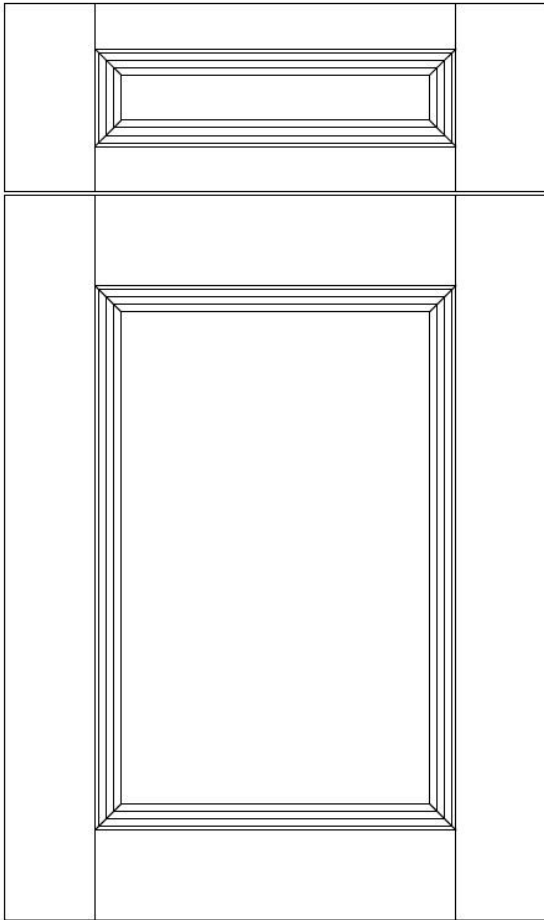

DOORS

Horizontal Rail Width:	3"
Vertical Rail Width:	3"
Door Frame Thickness:	3/4"
Panel Raise Profile:	Reversed 3/8" Panel
Inside Edge Profile:	AM3 Applied Molding
Overlay Outside Edge Profile:	Square Eased
Inset Outside Edge Profile:	Square Eased
Minimum Size:	9 3/8" W x 9 3/8" H

* Single panel doors larger than 24" W x 48" H will not be guaranteed against warpage.

5-PC DRAWER FRONTS

Horizontal Rail Width:	1 1/2"
Vertical Rail Width:	2 1/4"
Drawer Frame Thickness:	3/4"
Panel Raise Profile:	Reversed 3/8" Panel
Inside Edge Profile:	AM3 Applied Molding
Overlay Outside Edge Profile:	Square Eased
Inset Outside Edge Profile:	Square Eased
Minimum Size:	9 3/8" W x 6 3/8" H

DOOR PROFILE:

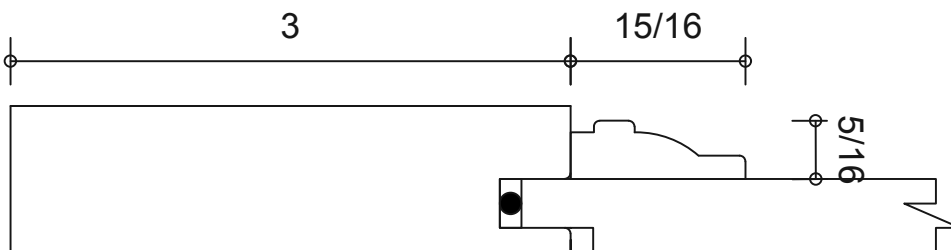

MULLION PROFILE:

Matching Mullion Doors Not Available In This Door Style.

DOOR STYLES

BRADBURY

Level Two - Applied Molding Door
Add \$84 Per Door/Drawer Front

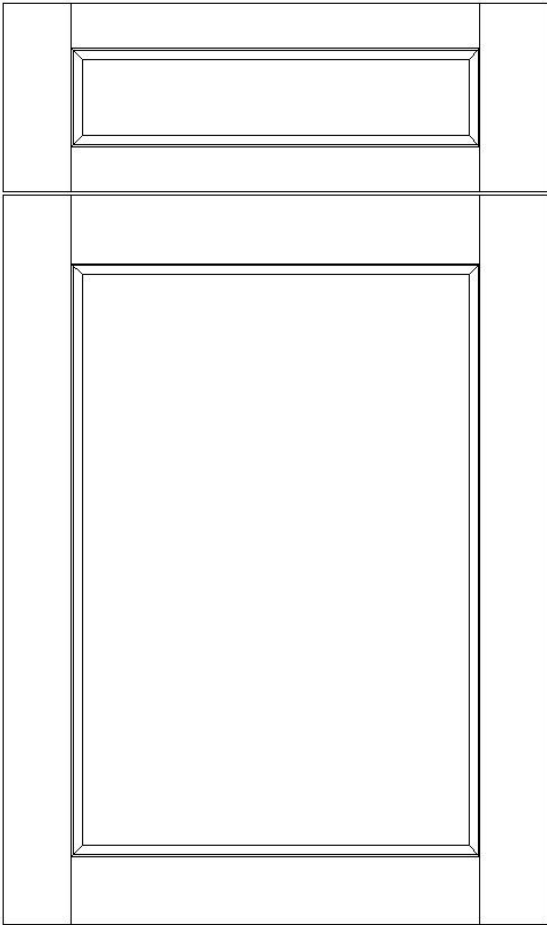

DOORS

Horizontal Rail Width:	2 1/4"
Vertical Rail Width:	2 1/4"
Door Frame Thickness:	3/4"
Panel Raise Profile:	Reversed 3/8" Panel
Inside Edge Profile:	AM2 Applied Molding
Overlay Outside Edge Profile:	Square Eased
Inset Outside Edge Profile:	Square Eased
Minimum Size:	6 1/2" W x 6 1/2" H

* Single panel doors larger than 24" W x 48" H will not be guaranteed against warpage.

5-PC DRAWER FRONTS

Horizontal Rail Width:	1 1/2"
Vertical Rail Width:	2 1/4"
Drawer Frame Thickness:	3/4"
Panel Raise Profile:	Reversed 3/8" Panel
Inside Edge Profile:	AM2 Applied Molding
Overlay Outside Edge Profile:	Square Eased
Inset Outside Edge Profile:	Square Eased
Minimum Size:	6 1/2" W x 5" H

DOOR PROFILE:

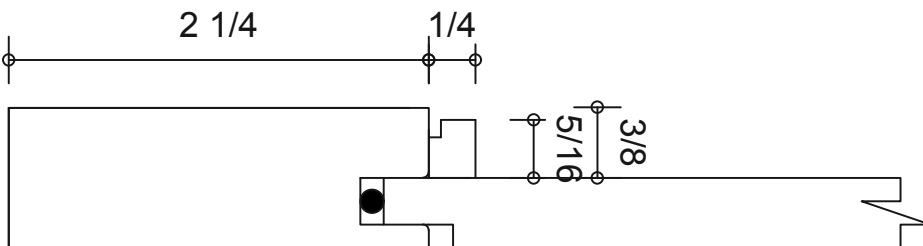

MULLION PROFILE:

Matching Mullion Doors Not Available In This Door Style.

DOOR STYLES

BRADBURY-3

Level Two - Applied Molding Door
Add \$84 Per Door/Drawer Front

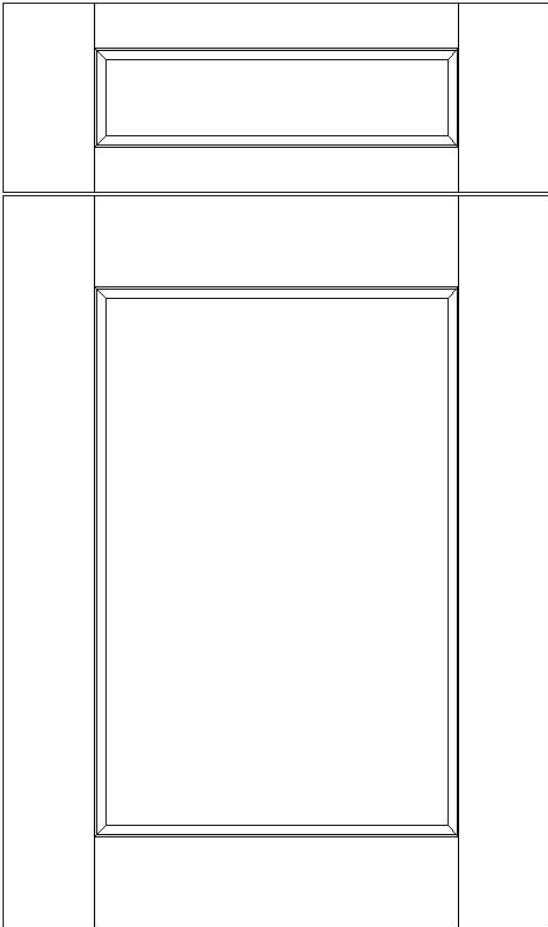

DOORS

Horizontal Rail Width:	3"
Vertical Rail Width:	3"
Door Frame Thickness:	3/4"
Panel Raise Profile:	Reversed 3/8" Panel
Inside Edge Profile:	AM2 Applied Molding
Overlay Outside Edge Profile:	Square Eased
Inset Outside Edge Profile:	Square Eased
Minimum Size:	8" W x 8" H

* Single panel doors larger than 24" W x 48" H will not be guaranteed against warpage.

5-PC DRAWER FRONTS

Horizontal Rail Width:	1 1/2"
Vertical Rail Width:	2 1/4"
Drawer Frame Thickness:	3/4"
Panel Raise Profile:	Reversed 3/8" Panel
Inside Edge Profile:	AM3 Applied Molding
Overlay Outside Edge Profile:	Square Eased
Inset Outside Edge Profile:	Square Eased
Minimum Size:	8" W x 5" H

DOOR PROFILE:

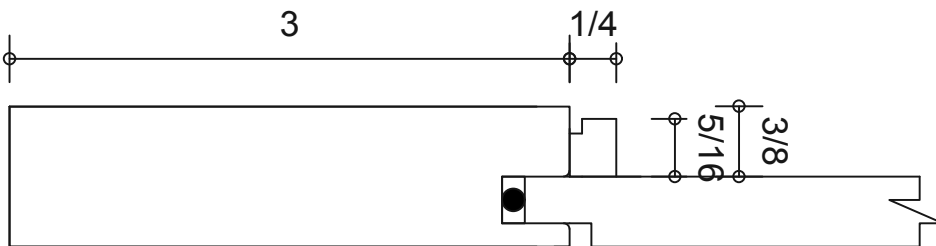

MULLION PROFILE:

Matching Mullion Doors Not Available In This Door Style.

DOOR STYLES

BRANIGAN

Level Two - Applied Molding Door
Add \$84 Per Door/Drawer Front

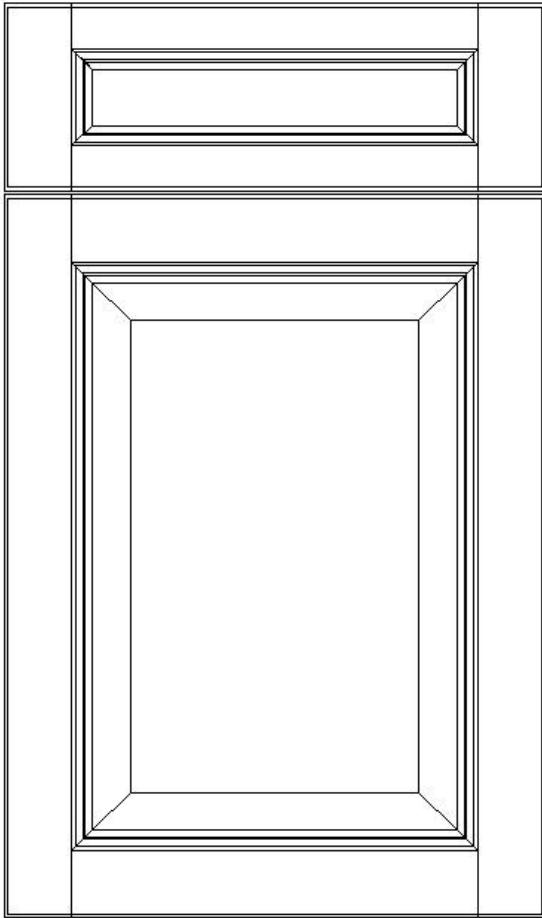

DOORS

Horizontal Rail Width:	2 1/4"
Vertical Rail Width:	2 1/4"
Door Frame Thickness:	3/4"
Panel Raise Profile:	Slant
Inside Edge Profile:	AM4 Applied Molding
Overlay Outside Edge Profile:	1/8" Radius
Inset Outside Edge Profile:	Square Eased
Minimum Size:	9 1/4" W X 9 1/4" H

*Single panel doors larger than 24" W x 48" H will not be guaranteed against warpage.

5-PC DRAWER FRONTS

Horizontal Rail Width:	1 1/2"
Vertical Rail Width:	2 1/4"
Drawer Frame Thickness:	3/4"
Panel Raise Profile:	Slant
Inside Edge Profile:	AM4 Applied Molding
Overlay Outside Edge Profile:	1/8" Radius
Inset Outside Edge Profile:	Square Eased
Minimum Size:	9 1/4" W x 7 3/4" H

DOOR PROFILE:

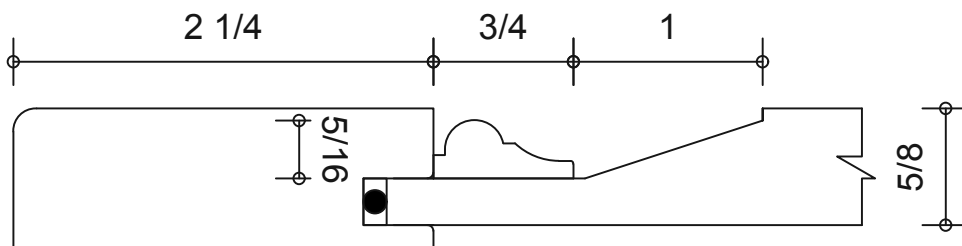

MULLION PROFILE:

Matching Mullion Doors Not Available In This Door Style.

DOOR STYLES

BRANIGAN-3

Level Two - Applied Molding Door
Add \$84 Per Door/Drawer Front

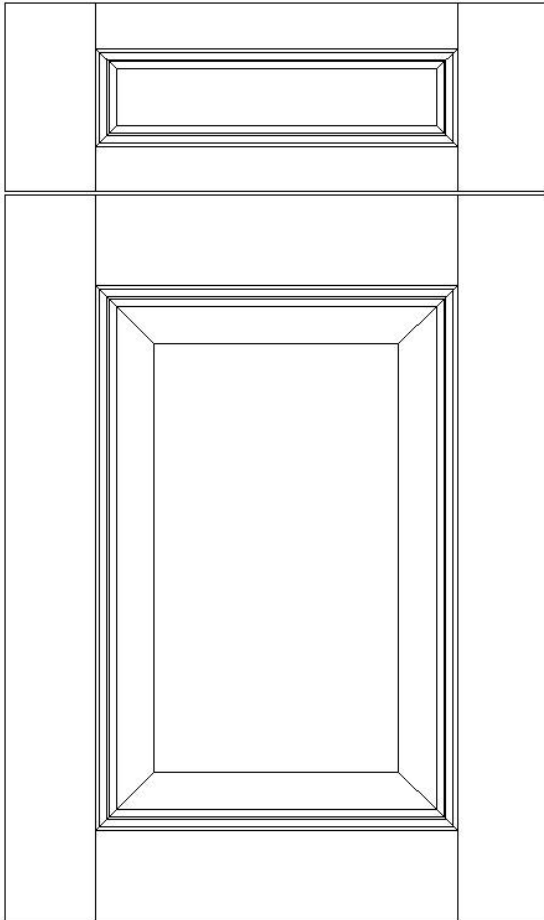

DOORS

- Horizontal Rail Width: 3"
- Vertical Rail Width: 3"
- Door Frame Thickness: 3/4"
- Panel Raise Profile: Slant
- Inside Edge Profile: AM4 Applied Molding
- Overlay Outside Edge Profile: 1/8" Radius
- Inset Outside Edge Profile: Square Eased
- Minimum Size: 10 3/4" W X 10 3/4" H

*Single panel doors larger than 24" W x 48" H will not be guaranteed against warpage.

5-PC DRAWER FRONTS

- Horizontal Rail Width: 1 1/2"
- Vertical Rail Width: 2 1/4"
- Drawer Frame Thickness: 3/4"
- Panel Raise Profile: Slant
- Inside Edge Profile: AM4 Applied Molding
- Overlay Outside Edge Profile: 1/8" Radius
- Inset Outside Edge Profile: Square Eased
- Minimum Size: 10 3/4" W x 7 3/4" H

DOOR PROFILE:

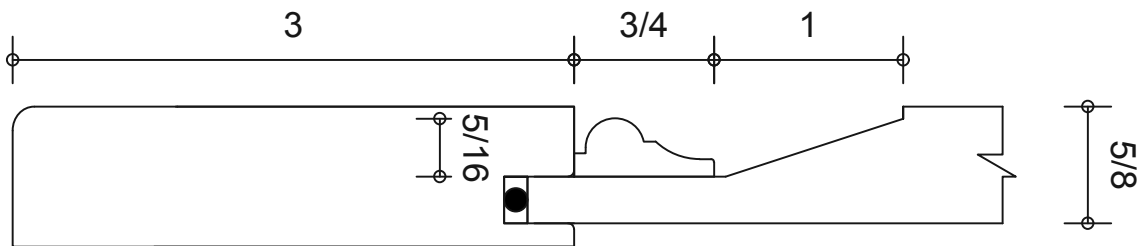

MULLION PROFILE:

Matching Mullion Doors Not Available In This Door Style.

DOOR STYLES

CAMDEN

Level Two - Frame & Panel Door
Add \$84 Per Door/Drawer Front

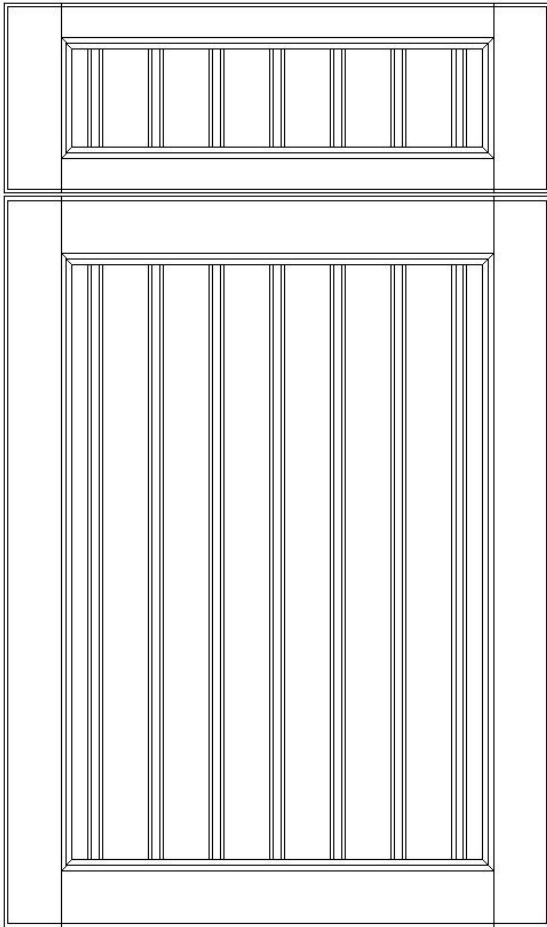

DOORS

Horizontal Rail Width:	2 1/4"
Vertical Rail Width:	2 1/4"
Door Frame Thickness:	3/4"
Panel Raise Profile:	Beaded Reversed 3/8" Panel
Inside Edge Profile:	Ogee
Overlay Outside Edge Profile:	Square Eased
Inset Outside Edge Profile:	Square Eased
Minimum Size:	6" W x 6" H

*Single panel doors larger than 24" x 48 will not be guaranteed against warpage.

5-PC DRAWER FRONTS

Horizontal Rail Width:	1 1/2"
Vertical Rail Width:	2 1/4"
Drawer Frame Thickness:	3/4"
Panel Raise Profile:	Reversed 3/8" Panel
Inside Edge Profile:	Ogee
Overlay Outside Edge Profile:	Square Eased
Inset Outside Edge Profile:	Square Eased
Minimum Size:	6" W X 4 1/2" H

NOTE: Standard beadboard spacing is 2" from center of bead to the center of the adjacent bead. Standard protocol is to center bead on door or drawer front and distribute equally left and right based on the above spacing. If a bead comes within 1/2" of the left or right edge of the panel, one bead is dropped from the overall panel and the center point is shifted to center between two beads.

DOOR PROFILE:

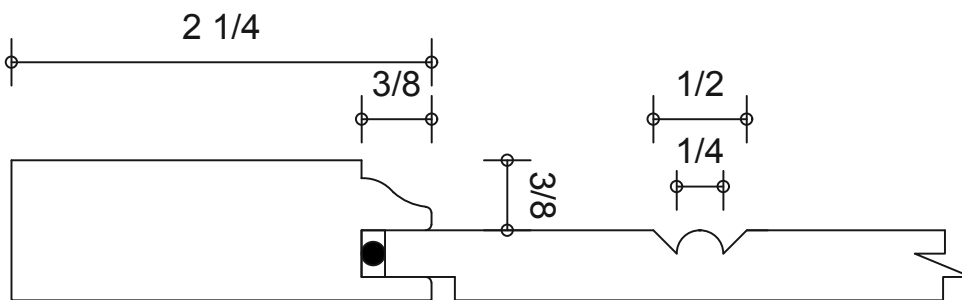

MULLION PROFILE:

Matching Mullion Doors Not Available In This Door Style.

DOOR STYLES

CAMDEN-3

Level Two - Frame & Panel Door
Add \$84 Per Door/Drawer Front

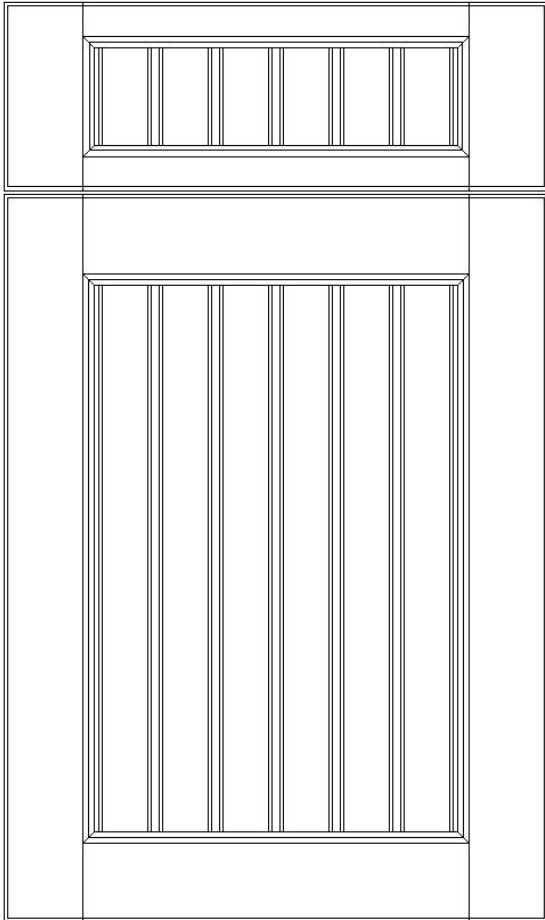

DOORS

Horizontal Rail Width:	3"
Vertical Rail Width:	3"
Door Frame Thickness:	3/4"
Panel Raise Profile:	Beaded Reversed 3/8" Panel
Inside Edge Profile:	Ogee
Overlay Outside Edge Profile:	Square Eased
Inset Outside Edge Profile:	Square Eased
Minimum Size:	7.5" W x 7.5" H

*Single panel doors larger than 24" x 48 will not be guaranteed against warpage.

5-PC DRAWER FRONTS

Horizontal Rail Width:	1 1/2"
Vertical Rail Width:	2 1/4"
Drawer Frame Thickness:	3/4"
Panel Raise Profile:	Reversed 3/8" Panel
Inside Edge Profile:	Ogee
Overlay Outside Edge Profile:	Square Eased
Inset Outside Edge Profile:	Square Eased
Minimum Size:	7.5" W X 4 1/2" H

NOTE: Standard beadboard spacing is 2" from center of bead to the center of the adjacent bead. Standard protocol is to center bead on door or drawer front and distribute equally left and right based on the above spacing. If a bead comes within 1/2" of the left or right edge of the panel, one bead is dropped from the overall panel and the center point is shifted to center between two beads.

DOOR PROFILE:

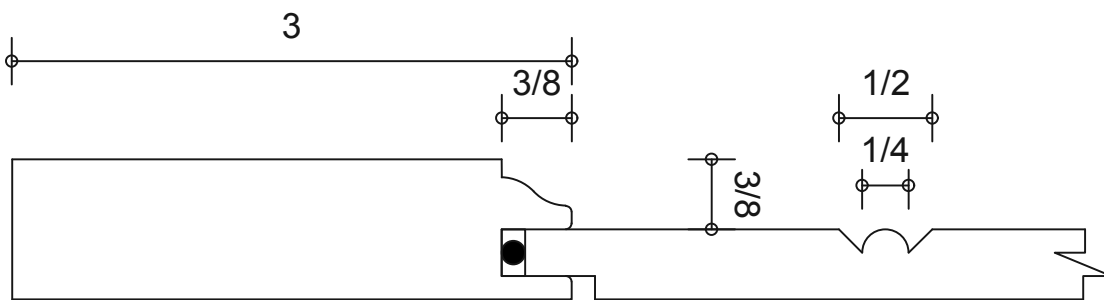

MULLION PROFILE:

Matching Mullion Doors Not Available In This Door Style.

DOOR STYLES

CODDINGTON

Level Two - Applied Molding Door
Add \$84 Per Door/Drawer Front

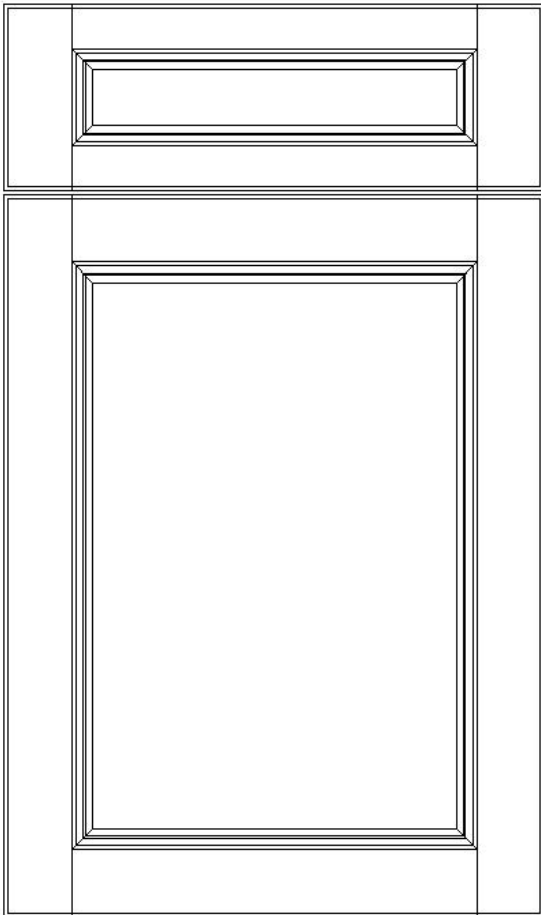

DOORS

Horizontal Rail Width:	2 1/4"
Vertical Rail Width:	2 1/4"
Door Frame Thickness:	3/4"
Panel Raise Profile:	Reversed 3/8" Panel
Inside Edge Profile:	AM4 Applied Molding
Overlay Outside Edge Profile:	1/8" Radius
Inset Outside Edge Profile:	Square Eased
Minimum Size:	7 1/2" W x 7 1/2" H

*Single panel doors larger than 24" W x 48" H will not be guaranteed against warpage.

5-PC DRAWER FRONTS

Horizontal Rail Width:	1 1/2"
Vertical Rail Width:	2 1/4"
Drawer Frame Thickness:	3/4"
Panel Raise Profile:	Reversed 3/8" Panel
Inside Edge Profile:	AM4 Applied Molding
Overlay Outside Edge Profile:	1/8" Radius
Inset Outside Edge Profile:	Square Eased
Minimum Size:	7" W x 6" H

DOOR PROFILE:

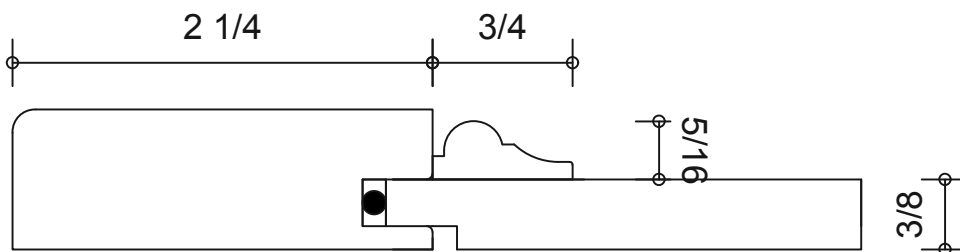

MULLION PROFILE:

Matching Mullion Doors Not Available In This Door Style.

DOOR STYLES

CODDINGTON-3

Level Two - Applied Molding Door
Add \$84 Per Door/Drawer Front

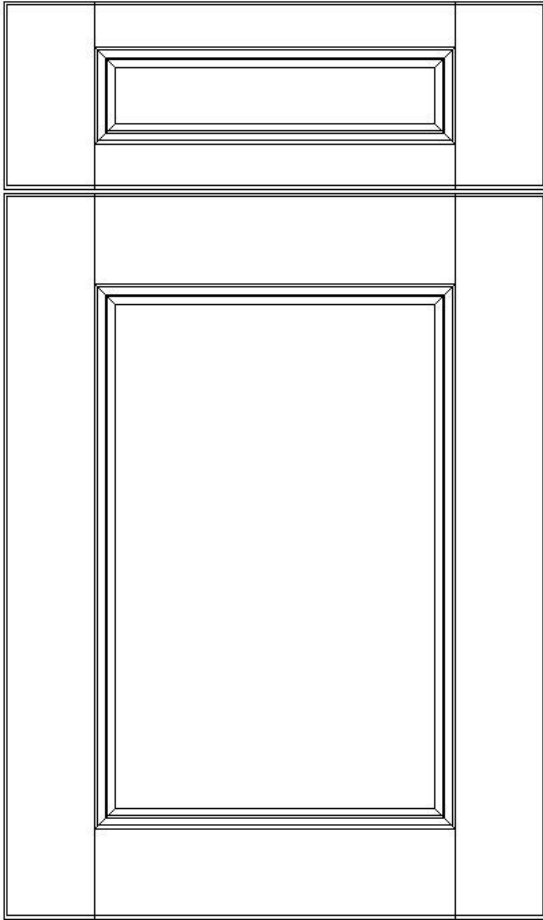

DOORS

Horizontal Rail Width:	3"
Vertical Rail Width:	3"
Door Frame Thickness:	3/4"
Panel Raise Profile:	Reversed 3/8" Panel
Inside Edge Profile:	AM4 Applied Molding
Overlay Outside Edge Profile:	1/8" Radius
Inset Outside Edge Profile:	Square Eased
Minimum Size:	9" W x 9" H

*Single panel doors larger than 24" W x 48" H will not be guaranteed against warpage.

5-PC DRAWER FRONTS

Horizontal Rail Width:	1 1/2"
Vertical Rail Width:	3"
Drawer Frame Thickness:	3/4"
Panel Raise Profile:	Reversed 3/8" Panel
Inside Edge Profile:	AM4 Applied Molding
Overlay Outside Edge Profile:	1/8" Radius
Inset Outside Edge Profile:	Square Eased
Minimum Size:	9" W x 6" H

DOOR PROFILE:

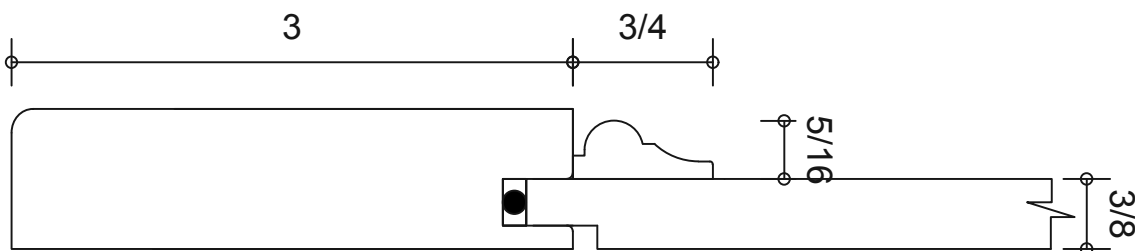

MULLION PROFILE:

Matching Mullion Doors Not Available In This Door Style.

DOOR STYLES

FRANKLIN

Level Two - Applied Molding Door
Add \$84 Per Door/Drawer Front

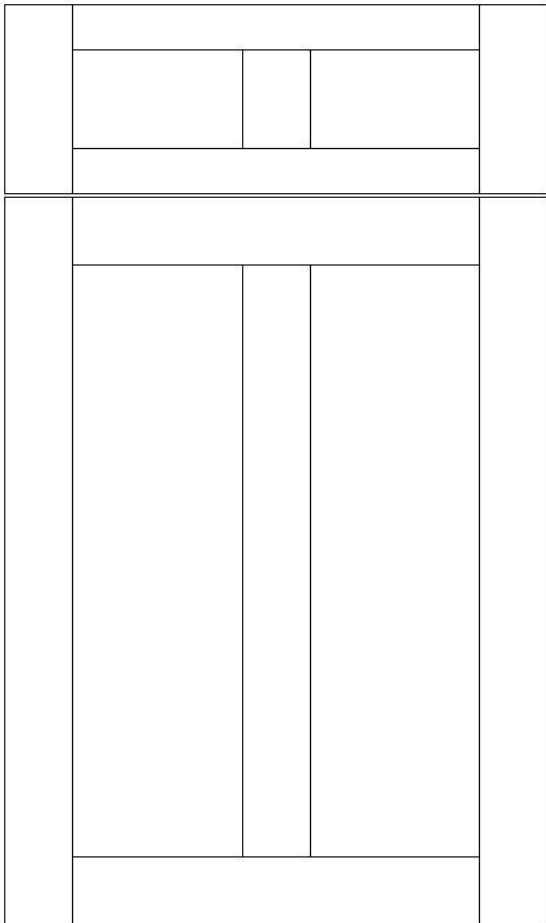

DOORS

Horizontal Rail Width:	2 1/4"
Vertical Rail Width:	2 1/4"
Door Frame Thickness:	3/4"
Panel Raise Profile:	Reversed 3/8" Panel
Inside Edge Profile:	Square
Overlay Outside Edge Profile:	Square Eased
Inset Outside Edge Profile:	Square Eased
Minimum Size:	9 3/4" x 6" H

*Single panel doors larger than 24" W x 48" H will not be guaranteed against warpage.

5-PC DRAWER FRONTS

Horizontal Rail Width:	1 1/2"
Vertical Rail Width:	2 1/4"
Drawer Frame Thickness:	3/4"
Panel Raise Profile:	Reversed 3/8" Panel
Inside Edge Profile:	Square
Overlay Outside Edge Profile:	Square Eased
Inset Outside Edge Profile:	Square Eased
Minimum Size:	9 3/4" W x 4.5" H

Doors below minimum size will become a MacIntosh door.

DOOR PROFILE:

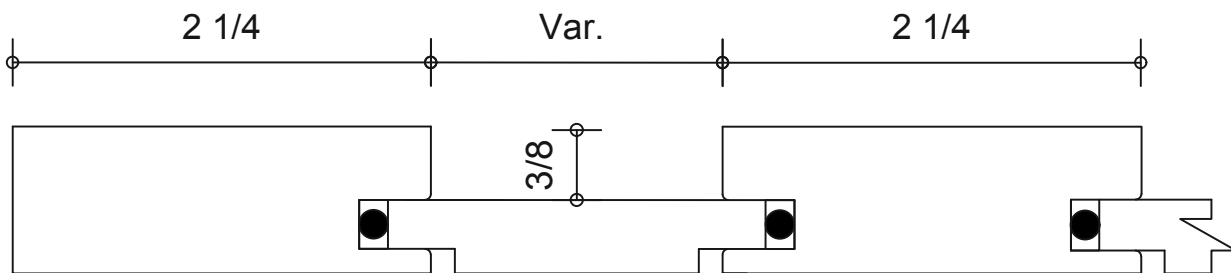

MULLION PROFILE:

Matching Mullion Doors Not Available In This Door Style.

DOOR STYLES

FRANKLIN-3

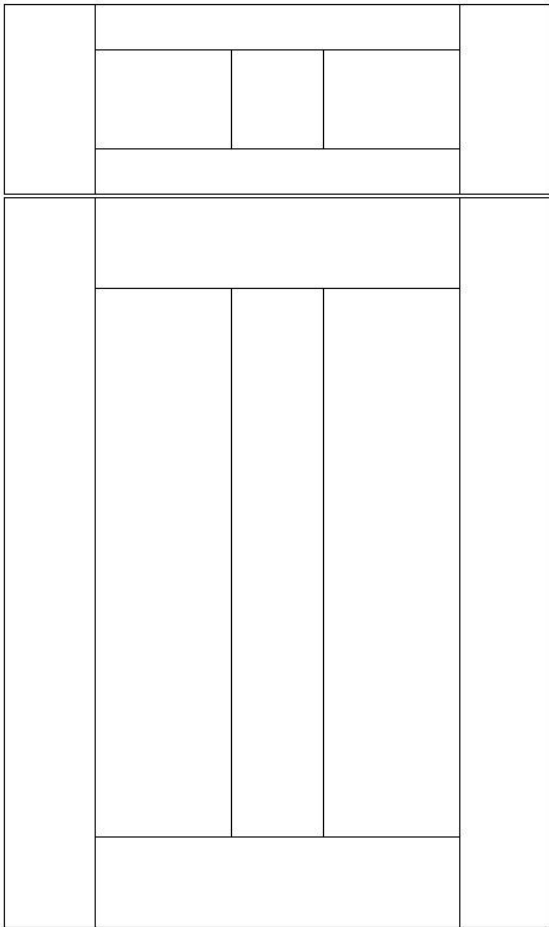

Level Two - Applied Molding Door

Add \$84 Per Door/Drawer Front

DOORS

Horizontal Rail Width:	3"
Vertical Rail Width:	3"
Door Frame Thickness:	3/4"
Panel Raise Profile:	Reversed 3/8" Panel
Inside Edge Profile:	Square
Overlay Outside Edge Profile:	Square Eased
Inset Outside Edge Profile:	Square Eased
Minimum Size:	12" W x 7.5" H

*Single panel doors larger than 24" W x 48" H will not be guaranteed against warpage.

5-PC DRAWER FRONTS

Horizontal Rail Width:	1 1/2"
Vertical Rail Width:	3"
Drawer Frame Thickness:	3/4"
Panel Raise Profile:	Reversed 3/8" Panel
Inside Edge Profile:	Square
Overlay Outside Edge Profile:	Square Eased
Inset Outside Edge Profile:	Square Eased
Minimum Size:	12" W x 4 1/2" H

Doors below minimum size will become a MacIntosh-3 door.

DOOR PROFILE:

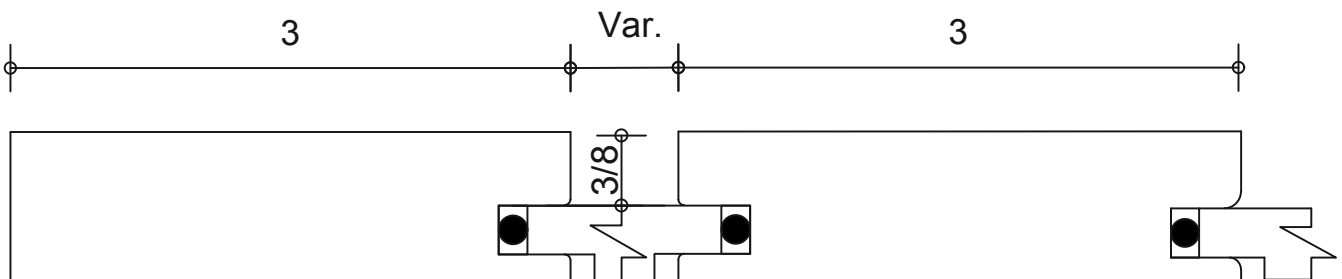

MULLION PROFILE:

Matching Mullion Doors Not Available In This Door Style.

DOOR STYLES

HARRINGTON

Level Two - Applied Molding Door
Add \$84 Per Door/Drawer Front

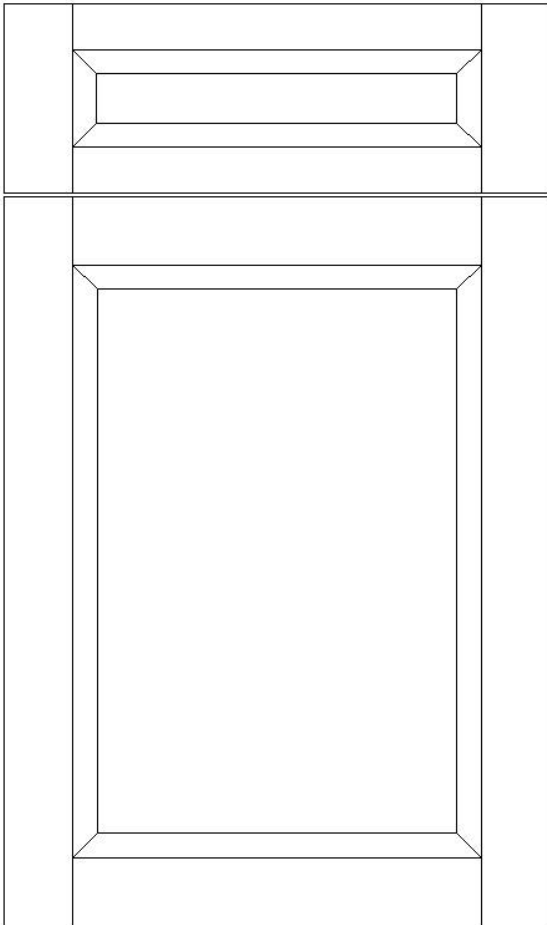

DOORS

Horizontal Rail Width:	2.25"
Vertical Rail Width:	2.25"
Door Frame Thickness:	3/4"
Panel Raise Profile:	Reversed 3/8" Panel
Inside Edge Profile:	AM15 Applied Molding
Overlay Outside Edge Profile:	Square Eased
Inset Outside Edge Profile:	Square Eased
Minimum Size:	7 5/8" W x 7 5/8" H

*Single panel doors larger than 24" W x 48" H will not be guaranteed against warpage.

5-PC DRAWER FRONTS

Horizontal Rail Width:	1 1/2"
Vertical Rail Width:	2.25"
Drawer Frame Thickness:	3/4"
Panel Raise Profile:	Reversed 3/8" Panel
Inside Edge Profile:	AM15 Applied Molding
Overlay Outside Edge Profile:	Square Eased
Inset Outside Edge Profile:	Square Eased
Minimum Size:	7 5/8" W x 6 1/8" H

DOOR PROFILE:

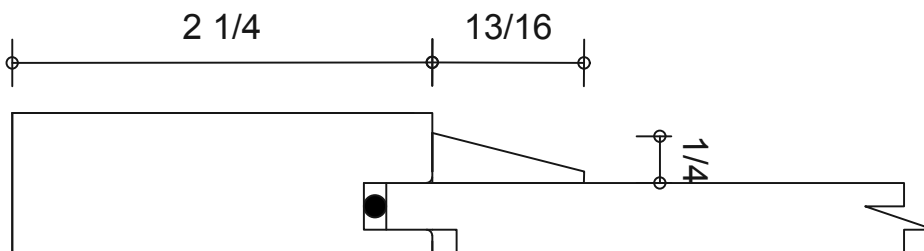

MULLION PROFILE:

Matching Mullion Doors Not Available In This Door Style.

DOOR STYLES

HARRINGTON-3

Level Two - Applied Molding Door
Add \$84 Per Door/Drawer Front

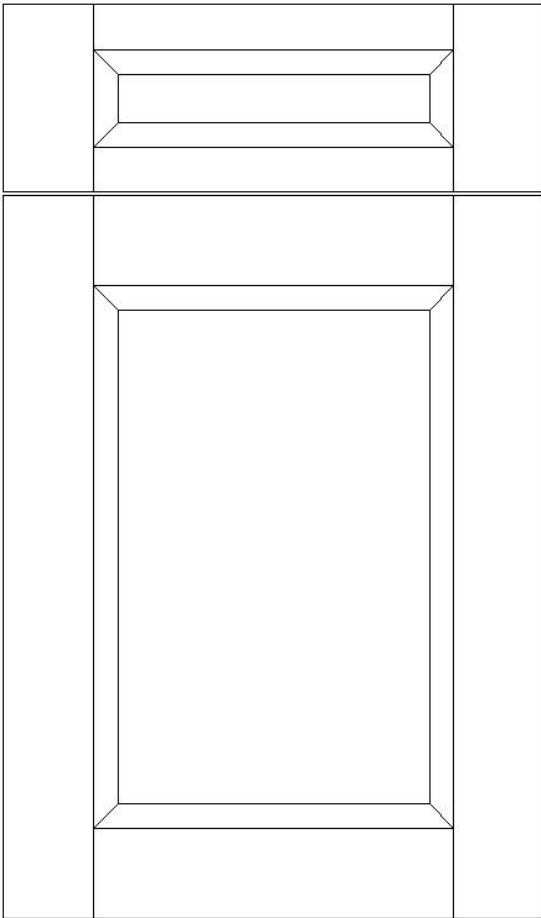

DOORS

Horizontal Rail Width:	3"
Vertical Rail Width:	3"
Door Frame Thickness:	3/4"
Panel Raise Profile:	Reversed 3/8" Panel
Inside Edge Profile:	AM15 Applied Molding
Overlay Outside Edge Profile:	Square Eased
Inset Outside Edge Profile:	Square Eased
Minimum Size:	9 1/8" W x 9 1/8" H

*Single panel doors larger than 24" W x 48" H will not be guaranteed against warpage.

5-PC DRAWER FRONTS

Horizontal Rail Width:	1 1/2"
Vertical Rail Width:	3"
Drawer Frame Thickness:	3/4"
Panel Raise Profile:	Reversed 3/8" Panel
Inside Edge Profile:	AM15 Applied Molding
Overlay Outside Edge Profile:	Square Eased
Inset Outside Edge Profile:	Square Eased
Minimum Size:	9 1/8" W x 6 1/8" H

DOOR PROFILE:

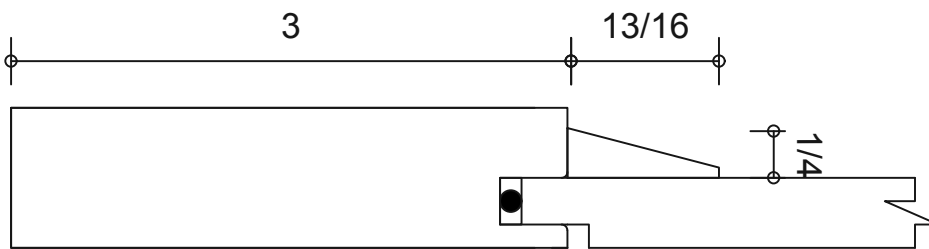

MULLION PROFILE:

Matching Mullion Doors Not Available In This Door Style.

DOOR STYLES

HATTERAS

Level Two - Applied Molding Door
Add \$84 Per Door/Drawer Front

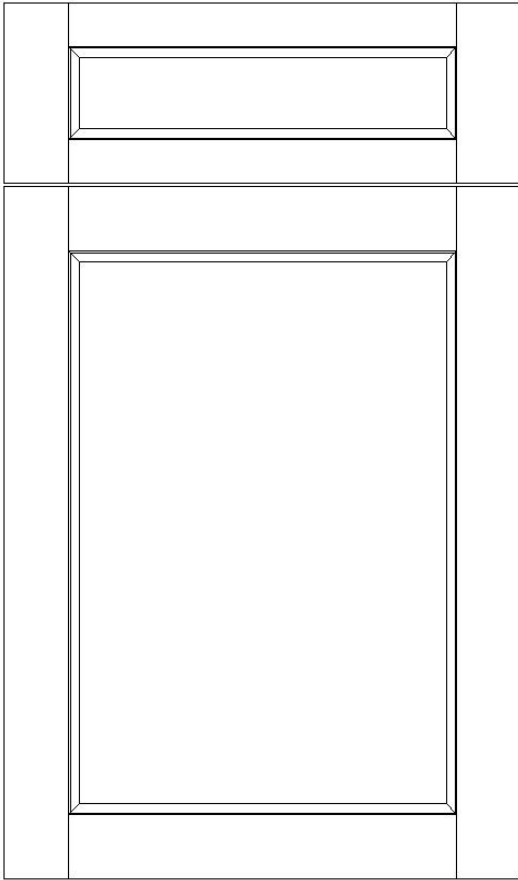

DOORS

Horizontal Rail Width:	2 1/4"
Vertical Rail Width:	2 1/4"
Door Frame Thickness:	3/4"
Panel Raise Profile:	Reversed 3/8" Panel
Inside Edge Profile:	AM1 Applied Molding
Overlay Outside Edge Profile:	Square Eased
Inset Outside Edge Profile:	Square Eased
Minimum Size:	6 1/2" W x 6 1/2" H

*Single panel doors larger than 24" W x 48" H will not be guaranteed against warpage.

5-PC DRAWER FRONTS

Horizontal Rail Width:	1 1/2"
Vertical Rail Width:	2 1/4"
Drawer Frame Thickness:	3/4"
Panel Raise Profile:	Reversed 3/8" Panel
Inside Edge Profile:	AM1 Applied Molding
Overlay Outside Edge Profile:	Square Eased
Inset Outside Edge Profile:	Square Eased
Minimum Size:	6 1/2" W x 5" H

DOOR PROFILE:

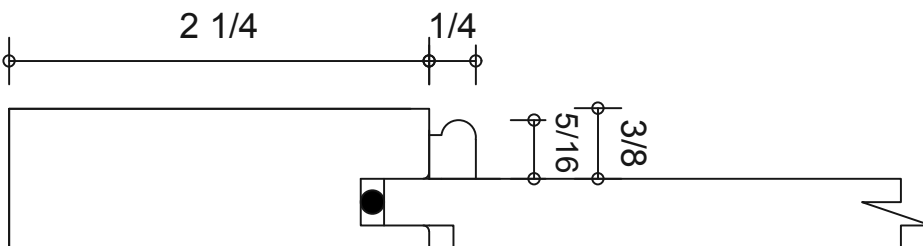

MULLION PROFILE:

Matching Mullion Doors Not Available In This Door Style.

DOOR STYLES

HATTERAS-3

Level Two - Applied Molding Door
Add \$84 Per Door/Drawer Front

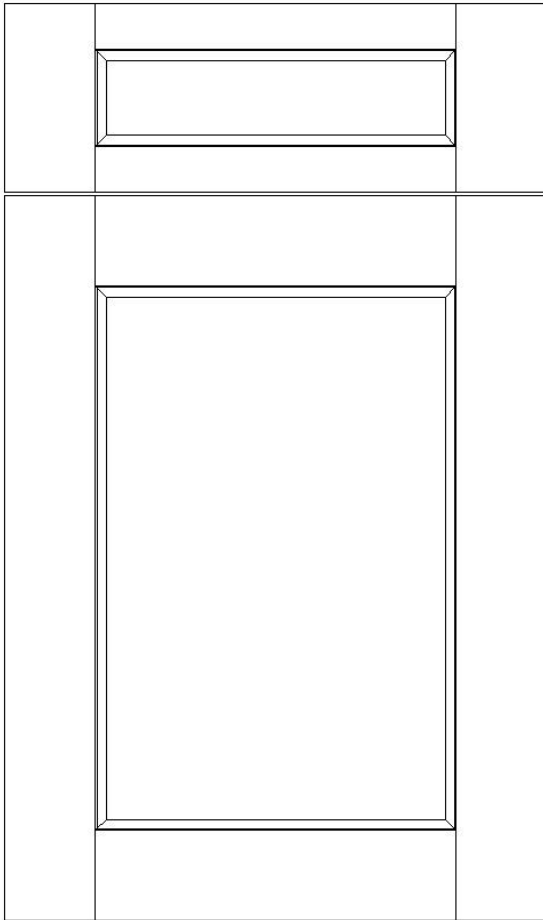

DOORS

Horizontal Rail Width:	3"
Vertical Rail Width:	3"
Door Frame Thickness:	3/4"
Panel Raise Profile:	Reversed 3/8" Panel
Inside Edge Profile:	AM1 Applied Molding
Overlay Outside Edge Profile:	Square Eased
Inset Outside Edge Profile:	Square Eased
Minimum Size:	8" W x 6 1/2" H

*Single panel doors larger than 24" W x 48" H will not be guaranteed against warpage.

5-PC DRAWER FRONTS

Horizontal Rail Width:	1 1/2"
Vertical Rail Width:	3"
Drawer Frame Thickness:	3/4"
Panel Raise Profile:	Reversed 3/8" Panel
Inside Edge Profile:	AM1 Applied Molding
Overlay Outside Edge Profile:	Square Eased
Inset Outside Edge Profile:	Square Eased
Minimum Size:	8" W x 5" H

DOOR PROFILE:

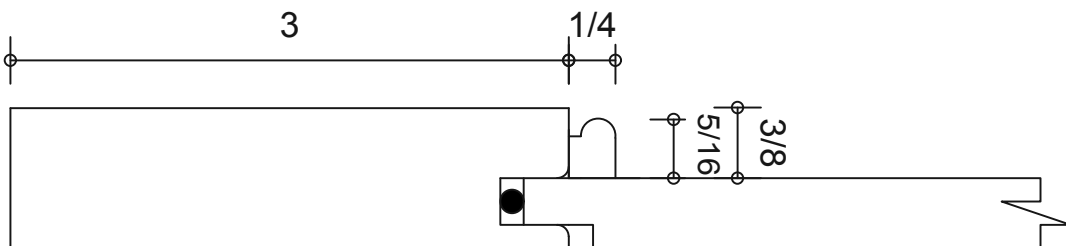

MULLION PROFILE:

Matching Mullion Doors Not Available In This Door Style.

DOOR STYLES

ARTS & CRAFTS

Level Three - Applied Molding Door
Add \$167 Per Door/Drawer Front

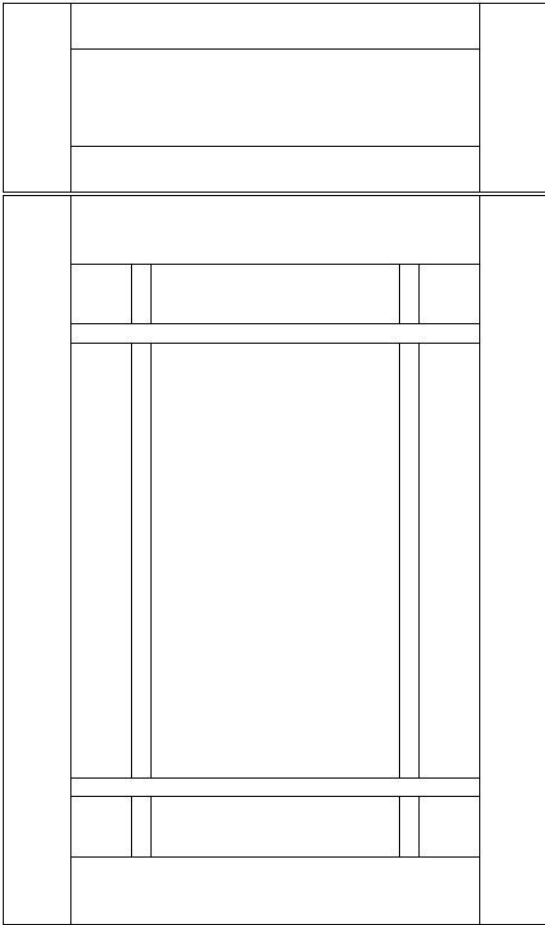

DOORS

Horizontal Rail Width:	2 1/4"
Vertical Rail Width:	2 1/4"
Door Frame Thickness:	3/4"
Panel Raise Profile:	Reversed 3/8" Panel
Inside Edge Profile:	Square
Overlay Outside Edge Profile:	Square Eased
Inset Outside Edge Profile:	Square Eased
Minimum Size:	11 3/4" W x 11 3/4" H

*Single panel doors larger than 24" W x 48" H will not be guaranteed against warpage.

5-PC DRAWER FRONTS

Horizontal Rail Width:	1 1/2"
Vertical Rail Width:	2 1/4"
Drawer Frame Thickness:	3/4"
Panel Raise Profile:	Reversed 3/8" Panel
Inside Edge Profile:	Square
Overlay Outside Edge Profile:	Square Eased
Inset Outside Edge Profile:	Square Eased
Minimum Size:	11 3/4" W x 10 1/4" H

Doors below minimum size will become a MacIntosh door.

DOOR PROFILE:

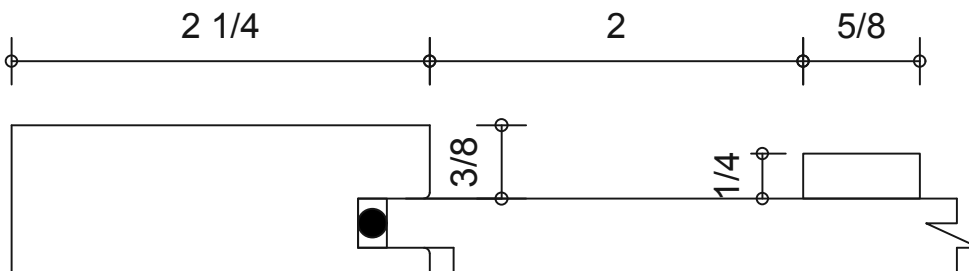

MULLION PROFILE:

Matching Mullion Doors Not Available In This Door Style.

DOOR STYLES

ARTS & CRAFTS-3

Level Three - Applied Molding Door
Add \$167 Per Door/Drawer Front

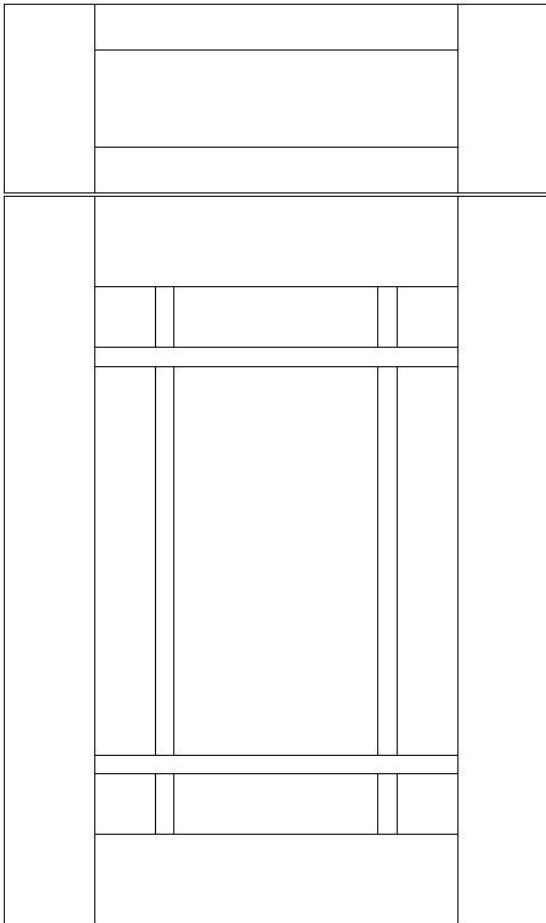

DOORS

- Horizontal Rail Width: 3"
- Vertical Rail Width: 3"
- Door Frame Thickness: 3/4"
- Panel Raise Profile: Reversed 3/8" Panel
- Inside Edge Profile: Square
- Overlay Outside Edge Profile: Square Eased
- Inset Outside Edge Profile: Square Eased
- Minimum Size: 13 1/4" x 13 1/4" H

*Single panel doors larger than 24" W x 48" H will not be guaranteed against warpage.

5-PC DRAWER FRONTS

- Horizontal Rail Width: 1 1/2"
- Vertical Rail Width: 3"
- Drawer Frame Thickness: 3/4"
- Panel Raise Profile: Reversed 3/8" Panel
- Inside Edge Profile: Square
- Overlay Outside Edge Profile: Square Eased
- Inset Outside Edge Profile: Square Eased
- Minimum Size: 13 1/4" W x 10 1/4" H

Doors below minimum size will become a MacIntosh-3 door.

DOOR PROFILE:

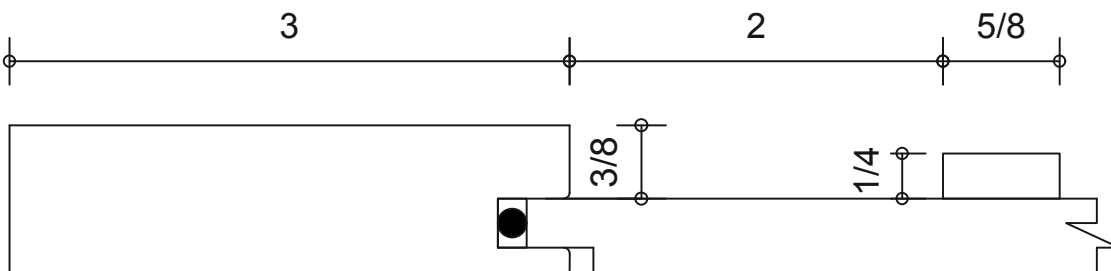

MULLION PROFILE:

Matching Mullion Doors Not Available In This Door Style.

DOOR STYLES

ESSENCE

Level Three - Applied Molding Door
Add \$167 Per Door/Drawer Front

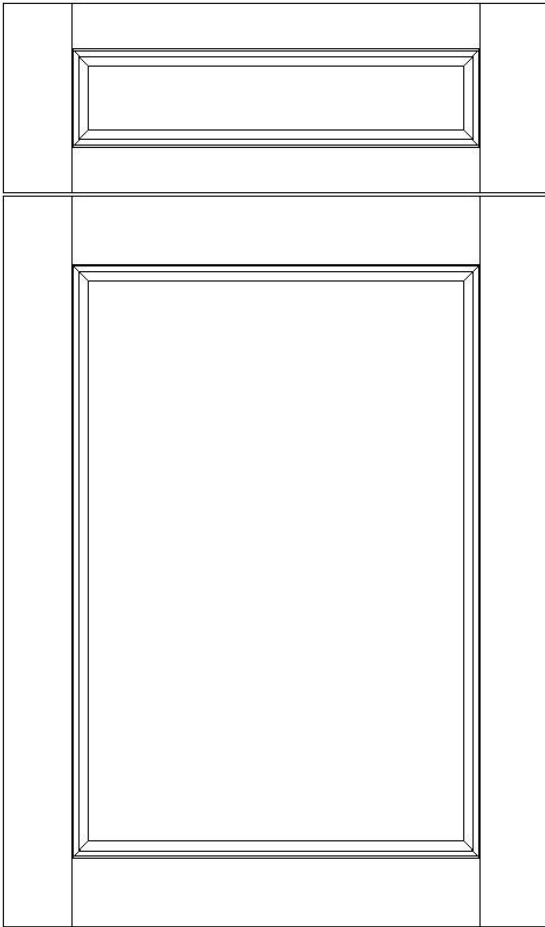

DOORS

Horizontal Rail Width:	2 1/4"
Vertical Rail Width:	2 1/4"
Door Frame Thickness:	3/4"
Panel Raise Profile:	Reversed 3/8" Panel
Inside Edge Profile:	AM13 Applied Molding
Overlay Outside Edge Profile:	Square Eased
Inset Outside Edge Profile:	Square Eased
Minimum Size:	7.5" W x 7.5" H

*Single panel doors larger than 24" W x 48" H will not be guaranteed against warpage.

5-PC DRAWER FRONTS

Horizontal Rail Width:	1 1/2"
Vertical Rail Width:	2 1/4"
Drawer Frame Thickness:	3/4"
Panel Raise Profile:	Reversed 3/8" Panel
Inside Edge Profile:	AM13 Applied Molding
Overlay Outside Edge Profile:	Square Eased
Inset Outside Edge Profile:	Square Eased
Minimum Size:	7.5" W x 6" H

DOOR PROFILE:

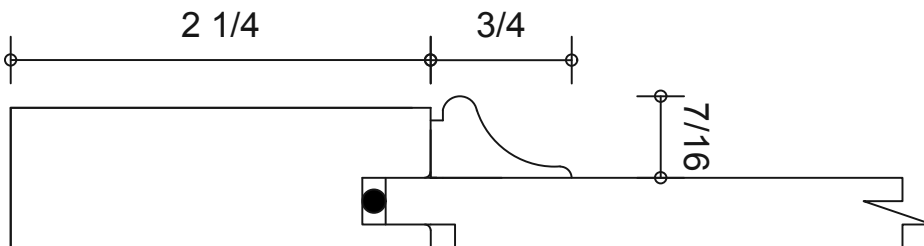

MULLION PROFILE:

Matching Mullion Doors Not Available In This Door Style.

DOOR STYLES

ESSENCE-3

Level Three - Applied Molding Door
Add \$167 Per Door/Drawer Front

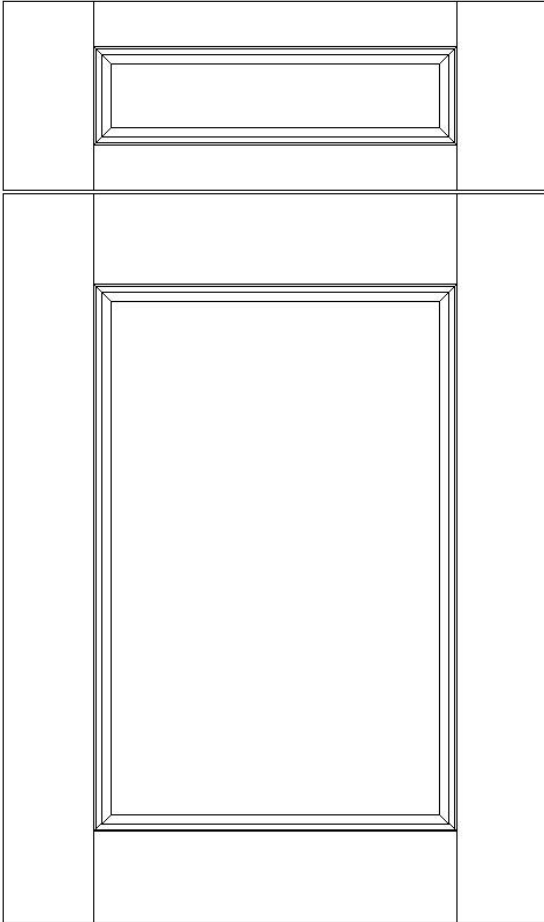

DOORS

Horizontal Rail Width:	3"
Vertical Rail Width:	3"
Door Frame Thickness:	3/4"
Panel Raise Profile:	Reversed 3/8" Panel
Inside Edge Profile:	AM13 Applied Molding
Overlay Outside Edge Profile:	Square Eased
Inset Outside Edge Profile:	Square Eased
Minimum Size:	9" W x 9" H

*Single panel doors larger than 24" W x 48" H will not be guaranteed against warpage.

5-PC DRAWER FRONTS

Horizontal Rail Width:	1 1/2"
Vertical Rail Width:	3"
Drawer Frame Thickness:	3/4"
Panel Raise Profile:	Reversed 3/8" Panel
Inside Edge Profile:	AM13 Applied Molding
Overlay Outside Edge Profile:	Square Eased
Inset Outside Edge Profile:	Square Eased
Minimum Size:	9" W x 6" H

DOOR PROFILE:

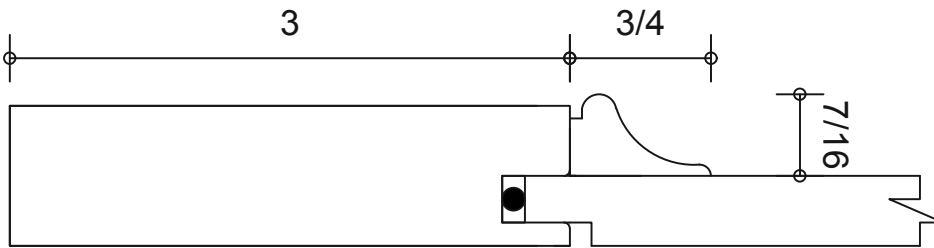

MULLION PROFILE:

Matching Mullion Doors Not Available In This Door Style.

DOOR STYLES

EXCALIBUR

Level Three - Applied Molding Door
Add \$167 Per Door/Drawer Front

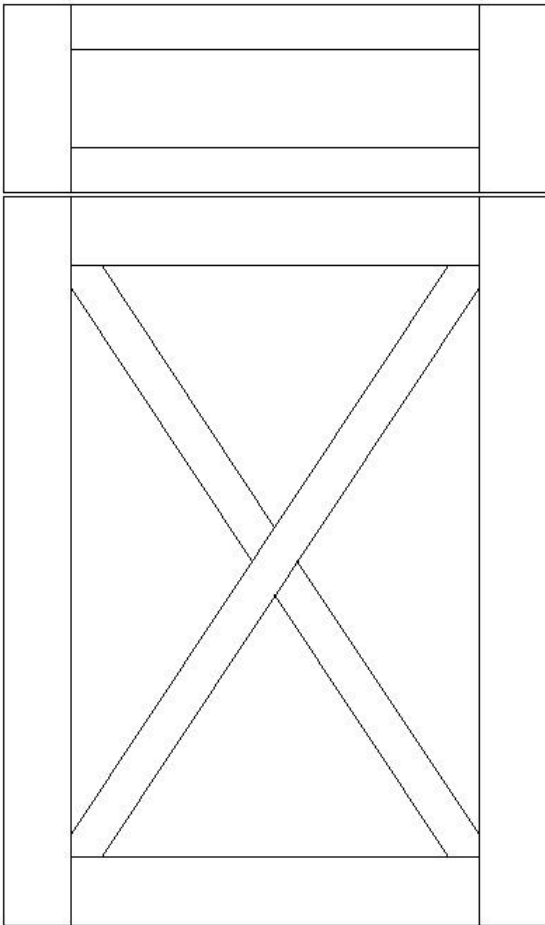

DOORS

- Horizontal Rail Width: 2 1/4"
- Vertical Rail Width: 2 1/4"
- Door Frame Thickness: 3/4"
- Panel Raise Profile: Reversed 3/8" Panel
- Inside Edge Profile: Square
- Overlay Outside Edge Profile: Square Eased
- Inset Outside Edge Profile: Square Eased
- Minimum Size: 6" W x 6" H

*Single panel doors larger than 24" W x 48" H will not be guaranteed against warpage.

5-PC DRAWER FRONTS

- Horizontal Rail Width: 1 1/2"
- Vertical Rail Width: 2 1/4"
- Drawer Frame Thickness: 3/4"
- Panel Raise Profile: Reversed 3/8" Panel
- Inside Edge Profile: Square
- Overlay Outside Edge Profile: Square Eased
- Inset Outside Edge Profile: Square Eased
- Minimum Size: 6" W x 4 1/2" H

Doors below minimum size will become a MacIntosh door.

This door appearance changes depending on width and height of door. A 12" x 15" will have a much different appearance than a 12" x 42. Approved CAD drawings required.

DOOR PROFILE:

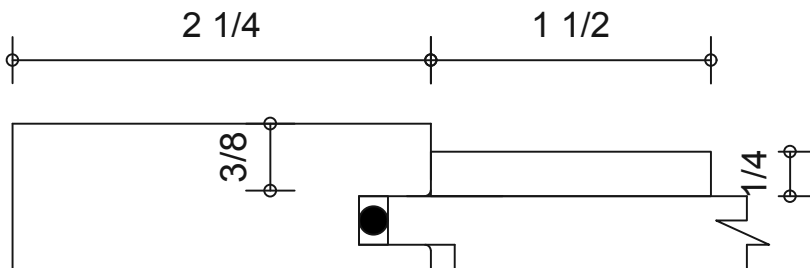

MULLION PROFILE:

Matching Mullion Doors Not Available In This Door Style.

DOOR STYLES

EXCALIBUR-3

Level Three - Applied Molding Door
Add \$167 Per Door/Drawer Front

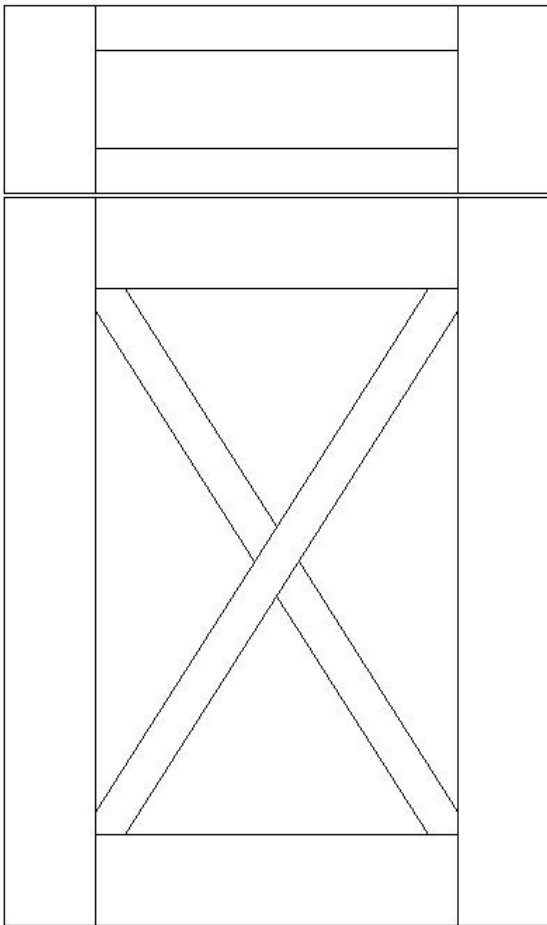

DOORS

Horizontal Rail Width:	3"
Vertical Rail Width:	3"
Door Frame Thickness:	3/4"
Panel Raise Profile:	Reversed 3/8" Panel
Inside Edge Profile:	Square
Overlay Outside Edge Profile:	Square Eased
Inset Outside Edge Profile:	Square Eased
Minimum Size:	7 1/2" W x 7 1/2" H

*Single panel doors larger than 24" W x 48" H will not be guaranteed against warpage.

5-PC DRAWER FRONTS

Horizontal Rail Width:	1 1/2"
Vertical Rail Width:	3"
Drawer Frame Thickness:	3/4"
Panel Raise Profile:	Reversed 3/8" Panel
Inside Edge Profile:	Square
Overlay Outside Edge Profile:	Square Eased
Inset Outside Edge Profile:	Square Eased
Minimum Size:	7 1/2" W x 4 1/2" H

Doors below minimum size will become a MacIntosh-3 door.

This door appearance changes depending on width and height of door. A 12" x 15" will have a much different appearance than a 12" x 42. Approved CAD drawings required.

DOOR PROFILE:

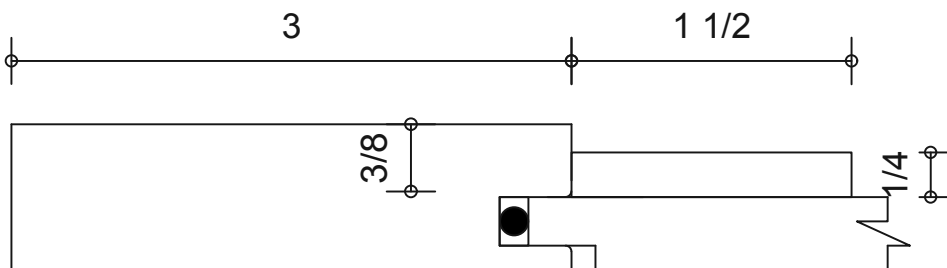

MULLION PROFILE:

Matching Mullion Doors Not Available In This Door Style.

DOOR STYLES

KINGSTON

Level Three - Applied Molding Door
Add \$167 Per Door/Drawer Front

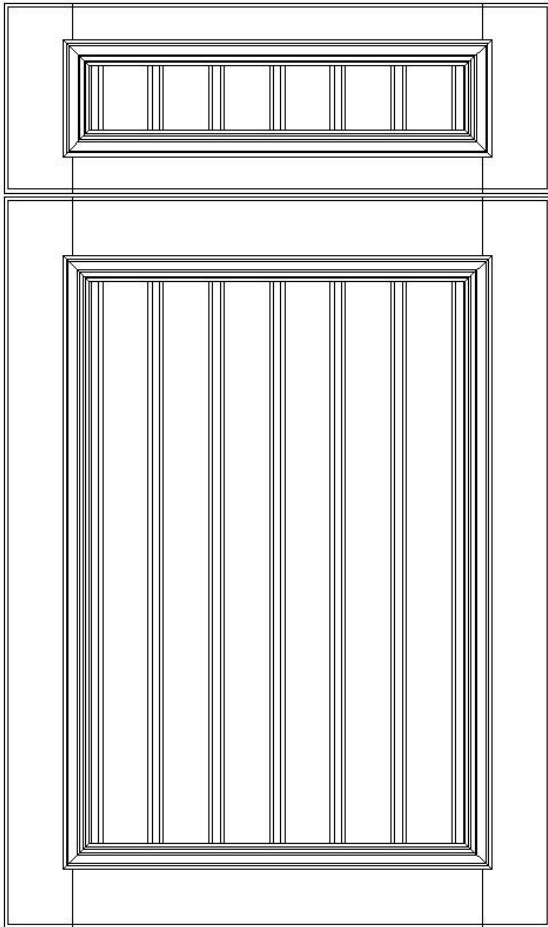

DOORS

Horizontal Rail Width:	2 1/4"
Vertical Rail Width:	2 1/4"
Door Frame Thickness:	3/4"
Panel Raise Profile:	Beaded Reversed 3/8" Panel
Inside Edge Profile:	AM6 Applied Molding
Overlay Outside Edge Profile:	1/8" Radius
Inset Outside Edge Profile:	Square Eased
Minimum Size:	7" W x 7" H

*Single panel doors larger than 24" W x 48" H will not be guaranteed against warpage.

5-PC DRAWER FRONTS

Horizontal Rail Width:	1 1/2"
Vertical Rail Width:	2 1/4"
Drawer Frame Thickness:	3/4"
Panel Raise Profile:	Beaded Reversed 3/8" Panel
Inside Edge Profile:	AM6 Applied Molding
Overlay Outside Edge Profile:	1/8" Radius
Inset Outside Edge Profile:	Square Eased
Minimum Size:	7" W x 5 1/2" H

NOTE: Standard beadboard spacing is 2" from center of bead to the center of the adjacent bead. Standard protocol is to center bead on door or drawer front and distribute equally left and right based on the above spacing. If a bead comes within 1/2" of the left or right edge of the panel, one bead is dropped from the overall panel and the center point is shifted to center between two beads.

DOOR PROFILE:

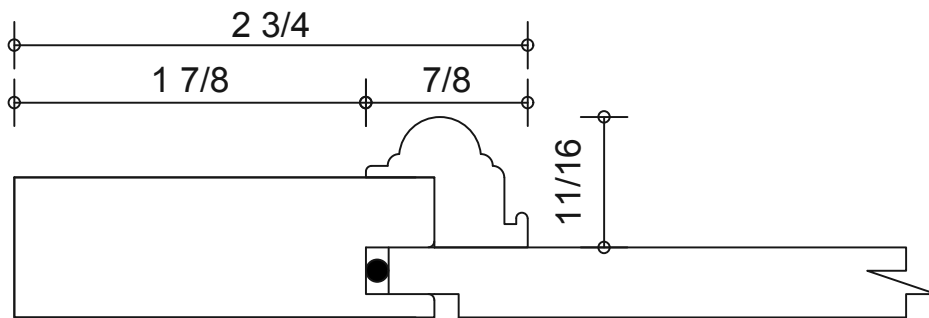

MULLION PROFILE:

Matching Mullion Doors Not Available In This Door Style.

DOOR STYLES

KINGSTON-3

Level Three - Applied Molding Door
Add \$167 Per Door/Drawer Front

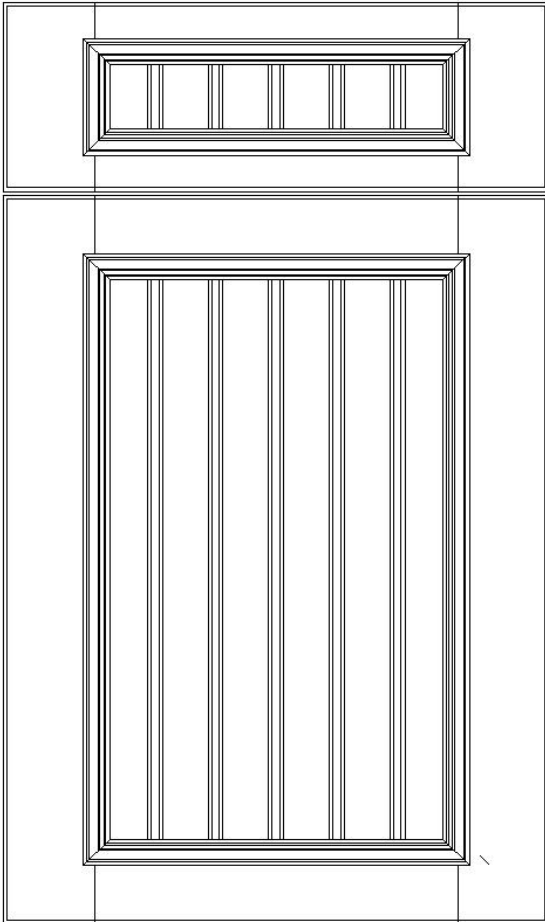

DOORS

Horizontal Rail Width:	3"
Vertical Rail Width:	3"
Door Frame Thickness:	3/4"
Panel Raise Profile:	Beaded Reversed 3/8" Panel
Inside Edge Profile:	AM6 Applied Molding
Overlay Outside Edge Profile:	1/8" Radius
Inset Outside Edge Profile:	Square Eased
Minimum Size:	8.5" W x 8.5" H

*Single panel doors larger than 24" W x 48" H will not be guaranteed against warpage.

5-PC DRAWER FRONTS

Horizontal Rail Width:	1 1/2"
Vertical Rail Width:	3"
Drawer Frame Thickness:	3/4"
Panel Raise Profile:	Beaded Reversed 3/8" Panel
Inside Edge Profile:	AM6 Applied Molding
Overlay Outside Edge Profile:	1/8" Radius
Inset Outside Edge Profile:	Square Eased
Minimum Size:	8.5" W x 5 1/2" H

NOTE: Standard beadboard spacing is 2" from center of bead to the center of the adjacent bead. Standard protocol is to center bead on door or drawer front and distribute equally left and right based on the above spacing. If a bead comes within 1/2" of the left or right edge of the panel, one bead is dropped from the overall panel and the center point is shifted to center between two beads.

DOOR PROFILE:

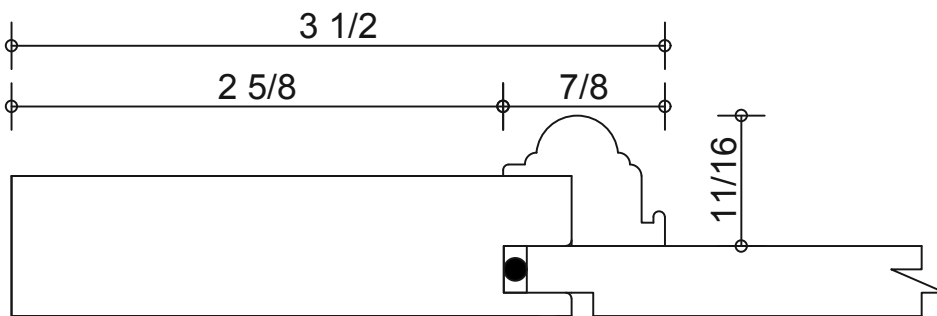

MULLION PROFILE:

Matching Mullion Doors Not Available In This Door Style.

DOOR STYLES

LEXINGTON

Level Three - Applied Molding Door
Add \$167 Per Door/Drawer Front

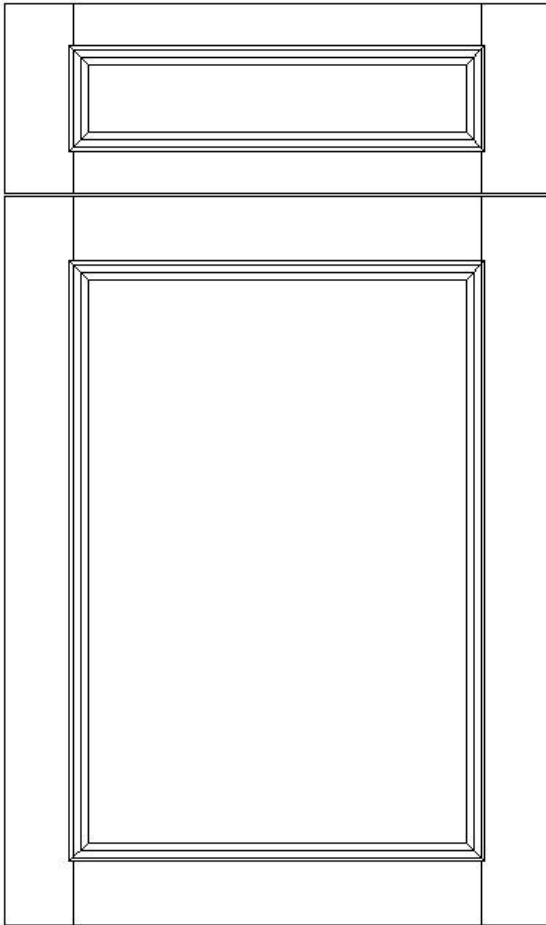

DOORS

Horizontal Rail Width:	2 1/4"
Vertical Rail Width:	2 1/4"
Door Frame Thickness:	3/4"
Panel Raise Profile:	Reversed 3/8" Panel
Inside Edge Profile:	AM5 Applied Molding
Overlay Outside Edge Profile:	1/4" Double Step
Inset Outside Edge Profile:	Square Eased
Minimum Size:	7 1/8" W x 7 1/8" H

*Single panel doors larger than 24" W x 48" H will not be guaranteed against warpage.

5-PC DRAWER FRONTS

Horizontal Rail Width:	1 1/2"
Vertical Rail Width:	2 1/4"
Drawer Frame Thickness:	3/4"
Panel Raise Profile:	Reversed 3/8" Panel
Inside Edge Profile:	AM5 Applied Molding
Overlay Outside Edge Profile:	1/4" Double Step
Inset Outside Edge Profile:	Square Eased
Minimum Size:	7 1/4" W x 5 5/8" H

8

DOOR PROFILE:

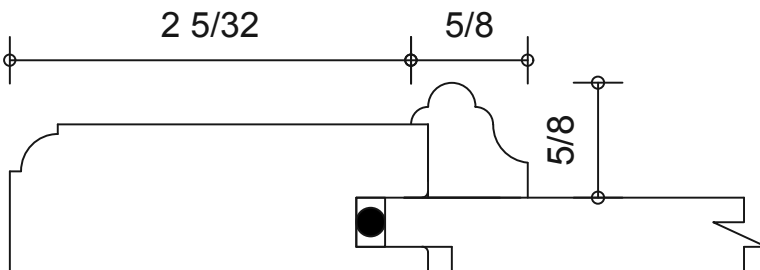

MULLION PROFILE:

Matching Mullion Doors Not Available In This Door Style.

DOOR STYLES

LEXINGTON-3

Level Three - Applied Molding Door
Add \$167 Per Door/Drawer Front

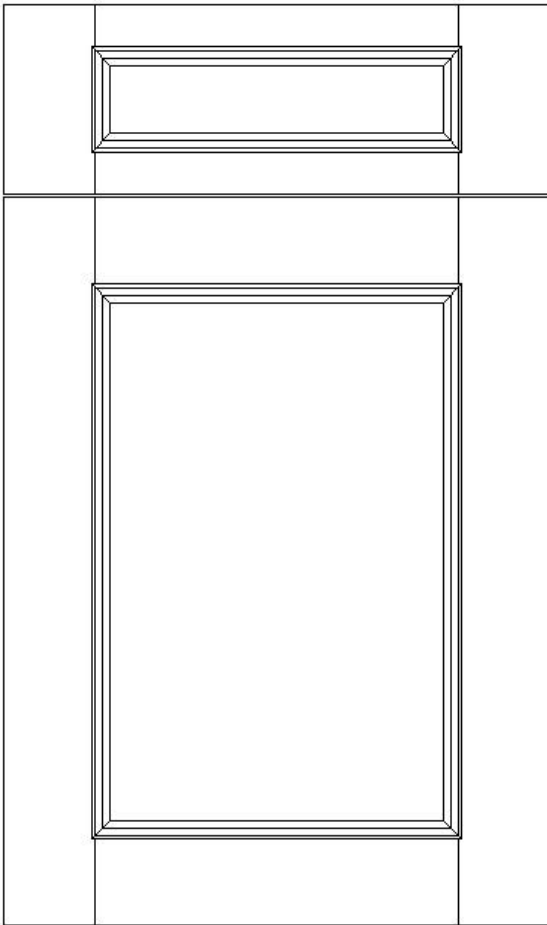

DOORS

Horizontal Rail Width:	3"
Vertical Rail Width:	3"
Door Frame Thickness:	3/4"
Panel Raise Profile:	Reversed 3/8" Panel
Inside Edge Profile:	AM5 Applied Molding
Overlay Outside Edge Profile:	1/4" Double Step
Inset Outside Edge Profile:	Square Eased
Minimum Size:	8 5/8" W x 8 5/8" H

*Single panel doors larger than 24" W x 48" H will not be guaranteed against warpage.

5-PC DRAWER FRONTS

Horizontal Rail Width:	1 1/2"
Vertical Rail Width:	3"
Drawer Frame Thickness:	3/4"
Panel Raise Profile:	Reversed 3/8" Panel
Inside Edge Profile:	AM5 Applied Molding
Overlay Outside Edge Profile:	1/4" Double Step
Inset Outside Edge Profile:	Square Eased
Minimum Size:	8 5/8" W x 5 5/8" H

DOOR PROFILE:

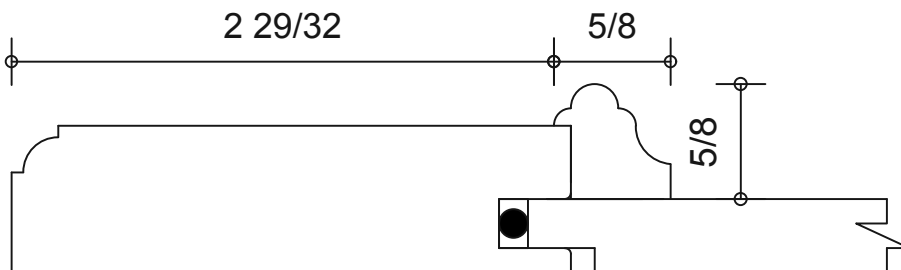

MULLION PROFILE:

Matching Mullion Doors Not Available In This Door Style.

DOOR STYLES

LINVILLE

Level Three - Applied Molding Door
Add \$167 Per Door/Drawer Front

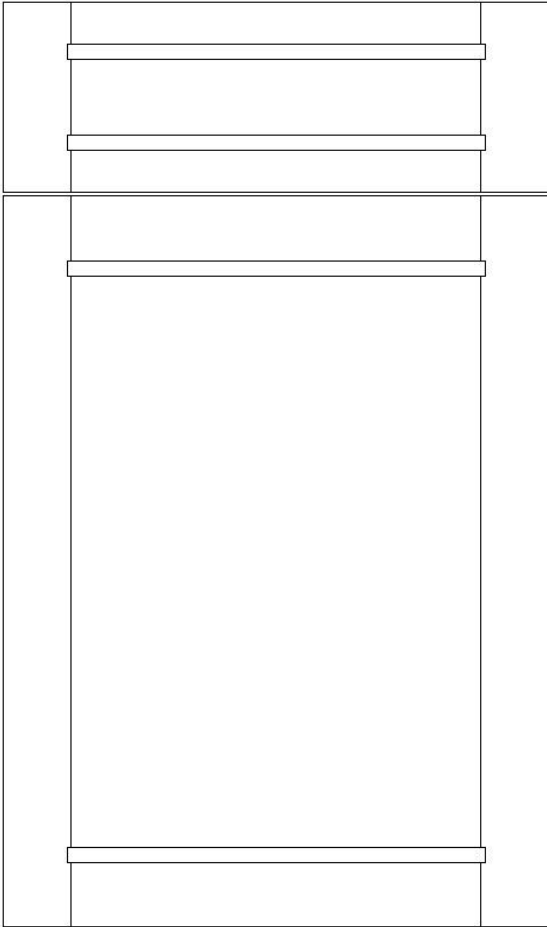

DOORS

Horizontal Rail Width:	2.25"
Vertical Rail Width:	2.25
Door Frame Thickness:	3/4"
Panel Raise Profile:	Reversed 3/8" Panel
Inside Edge Profile:	AM7 Applied Molding Square (Horizontal Only)
Overlay Outside Edge Profile:	Square Eased
Inset Outside Edge Profile:	Square Eased
Minimum Size:	6 3/4" W x 6 3/4" H

*Single panel doors larger than 24" W x 48" H will not be guaranteed against warpage.

5-PC DRAWER FRONTS

Horizontal Rail Width:	1 1/2"
Vertical Rail Width:	3"
Drawer Frame Thickness:	3/4"
Panel Raise Profile:	Reversed 3/8" Panel
Inside Edge Profile:	AM7 Applied Molding Square (Horizontal Only)
Overlay Outside Edge Profile:	Square Eased
Inset Outside Edge Profile:	Square Eased
Minimum Size:	6 3/4" W x 5 1/4" H

DOOR PROFILE:

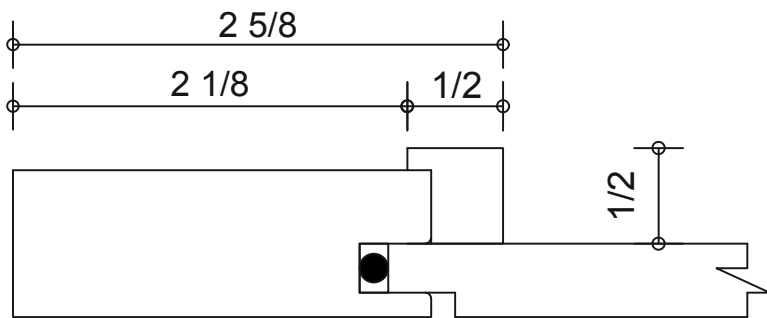

Horizontal Rails Only

MULLION PROFILE:

Matching Mullion Doors Not Available In This Door Style.

DOOR STYLES

LINVILLE-3

Level Three - Applied Molding Door
Add \$167 Per Door/Drawer Front

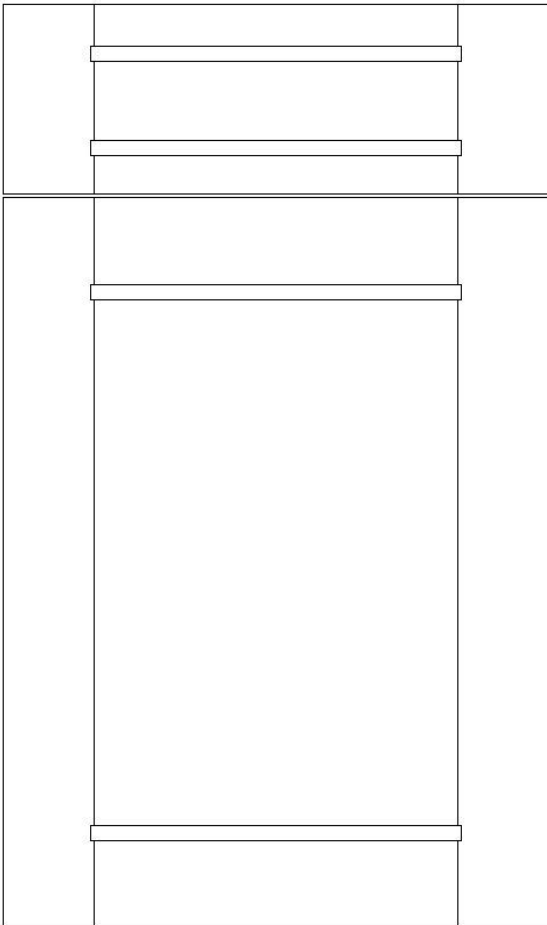

DOORS

Horizontal Rail Width:	3"
Vertical Rail Width:	3"
Door Frame Thickness:	3/4"
Panel Raise Profile:	Reversed 3/8" Panel
Inside Edge Profile:	AM7 Applied Molding Square (Horizontal Only)
Overlay Outside Edge Profile:	Square Eased
Inset Outside Edge Profile:	Square Eased
Minimum Size:	8 1/2" W x 7 1/2" H

*Single panel doors larger than 24" W x 48" H will not be guaranteed against warpage.

5-PC DRAWER FRONTS

Horizontal Rail Width:	1 1/2"
Vertical Rail Width:	3"
Drawer Frame Thickness:	3/4"
Panel Raise Profile:	Reversed 3/8" Panel
Inside Edge Profile:	AM7 Applied Molding Square (Horizontal Only)
Overlay Outside Edge Profile:	Square Eased
Inset Outside Edge Profile:	Square Eased
Minimum Size:	7 1/2" W x 5 1/4" H

DOOR PROFILE:



Horizontal Rails Only

MULLION PROFILE:

Matching Mullion Doors Not Available In This Door Style.

DOOR STYLES

TUSCANY HILL

Level Three - Applied Molding Door
Add \$167 Per Door/Drawer Front

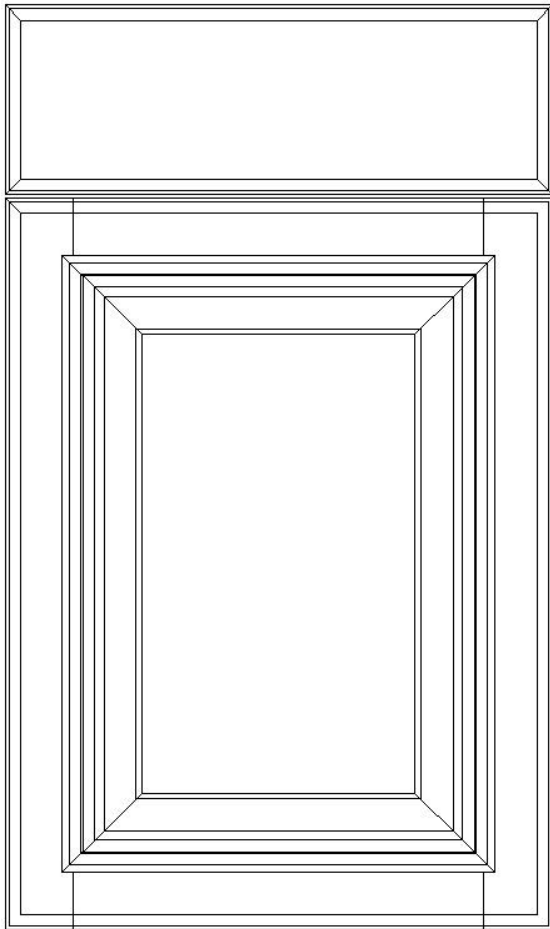

DOORS

Horizontal Rail Width:	2 1/4"
Vertical Rail Width:	2.1/4"
Door Frame Thickness:	3/4"
Panel Raise Profile:	Stepped Cove
Inside Edge Profile:	AM10 - Applied Molding
Overlay Outside Edge Profile:	Large Ogee
Inset Outside Edge Profile:	Square Eased
Minimum Size:	10" x 10"

*Single panel doors larger than 24" W x 48" H will not be guaranteed against warpage.

5-PC DRAWER FRONTS

Horizontal Rail Width:	1 1/2"
Vertical Rail Width:	2 1/4"
Drawer Frame Thickness:	3/4" (1 1/8" w/AM10)
Panel Raise Profile:	Stepped Cove
Inside Edge Profile:	AM10 Applied Molding
Overlay Outside Edge Profile:	Large Ogee
Inset Outside Edge Profile:	Square Eased
Minimum Size:	10" W x 8 1/2" H

DOOR PROFILE:

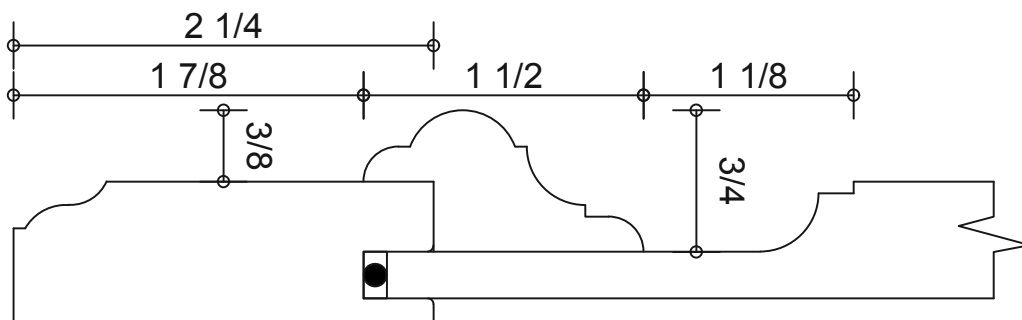

MULLION PROFILE:

Matching Mullion Doors Not Available In This Door Style.

DOOR STYLES

TUSCANY HILL-3 Level Three - Applied Molding Door Add \$167 Per Door/Drawer Front

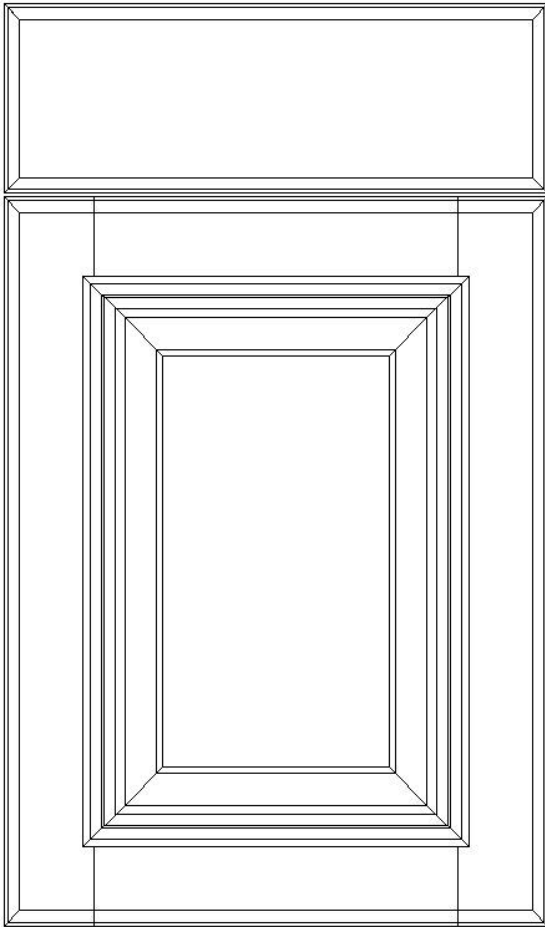

DOORS

Horizontal Rail Width:	2 1/4"
Vertical Rail Width:	2.1/4"
Door Frame Thickness:	3/4"
Panel Raise Profile:	Stepped Cove
Inside Edge Profile:	AM10 - Applied Molding
Overlay Outside Edge Profile:	Large Ogee
Inset Outside Edge Profile:	Square Eased
Minimum Size:	11 1/2" x 11 1/2"

*Single panel doors larger than 24" W x 48" H will not be guaranteed against warpage.

5-PC DRAWER FRONTS

Horizontal Rail Width:	1 1/2"
Vertical Rail Width:	2 1/4"
Drawer Frame Thickness:	3/4" (1 1/8" w/AM10)
Panel Raise Profile:	Stepped Cove
Inside Edge Profile:	AM10 Applied Molding
Overlay Outside Edge Profile:	Large Ogee
Inset Outside Edge Profile:	Square Eased
Minimum Size:	11 1/2" W x 8 1/2" H

DOOR PROFILE:

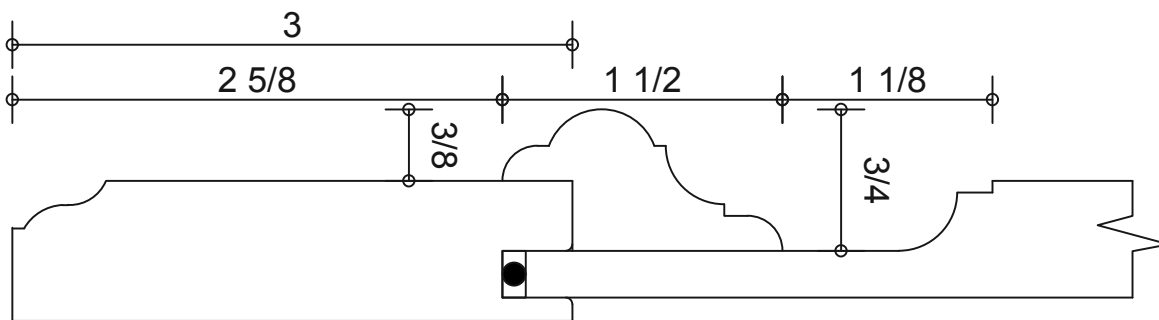

MULLION PROFILE:

Matching Mullion Doors Not Available In This Door Door Style.

DOOR STYLES

METROPOLITAN

Level Three - Applied Molding Door
Add \$167 Per Door/Drawer Front

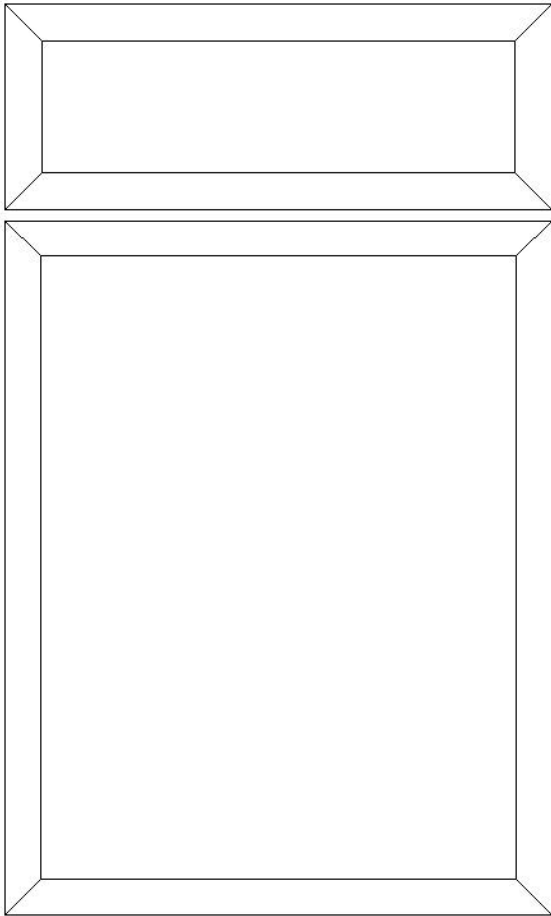

DOORS

Horizontal Rail Width:	N/A
Vertical Rail Width:	N/A
Door Thickness:	1" Including AM12 Edge
Panel Raise Profile:	N/A
Inside Edge Profile:	N/A
Overlay Outside Edge Profile:	AM12 Applied Molding
Inset Outside Edge Profile:	<u>Not Available In Inset</u>
Minimum Size:	6" W x 6" H

*Single panel doors larger than 24" W x 48" H will not be guaranteed against warpage.

DRAWER FRONTS

Horizontal Rail Width:	N/A
Vertical Rail Width:	N/A
Drawer Thickness:	1" Including AM12 Edge
Panel Raise Profile:	N/A
Inside Edge Profile:	N/A
Overlay Outside Edge Profile:	AM12 Applied Molding
Inset Outside Edge Profile:	<u>Not Available In Inset</u>
Minimum Size:	6" W x 6" H

DOOR PROFILE:

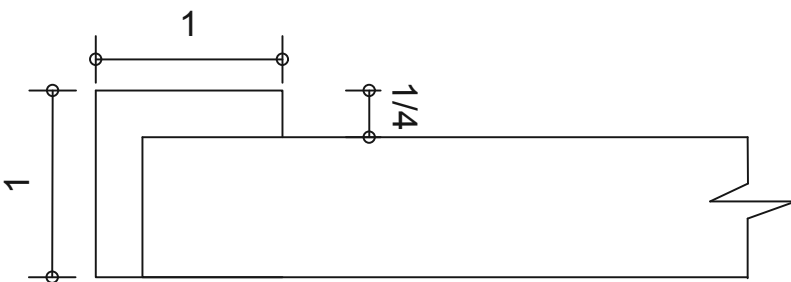

MULLION PROFILE:

Matching Mullion Doors Not Available In This Door Style.

DOOR STYLES

DRAWER FRONTS

SLAB DRAWER FRONT- Available All Doors Styles

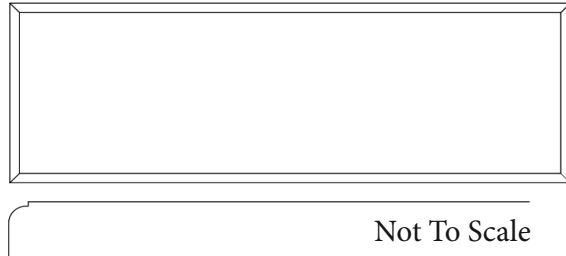

Available in all overlays.
All outside edge profiles available.
Shown with Step Round.

AM4 APPLIED MOLDING SLAB DRAWER FRONT - INSET ONLY

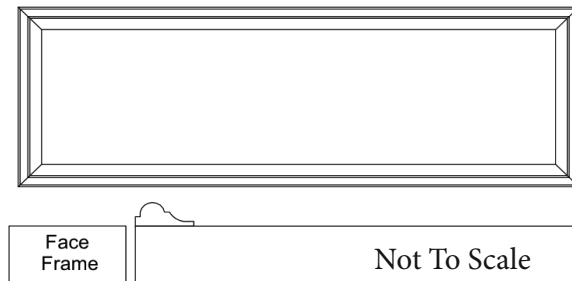

FOR USE
PRIMARILY WITH
BRANIGAN AND
CODDINGTON
DOOR STYLES

AM3 APPLIED MOLDING SLAB DRAWER FRONT - INSET ONLY

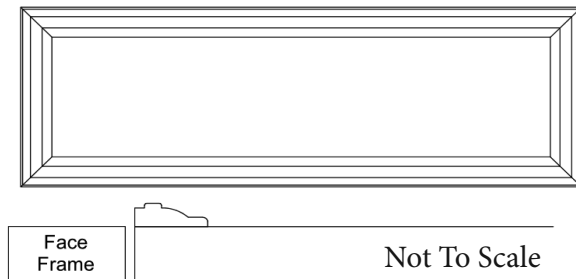

FOR USE
PRIMARILY WITH
BAILEY DOOR
STYLE

AM11 APPLIED MOLDING SLAB DRAWER FRONT - INSET ONLY

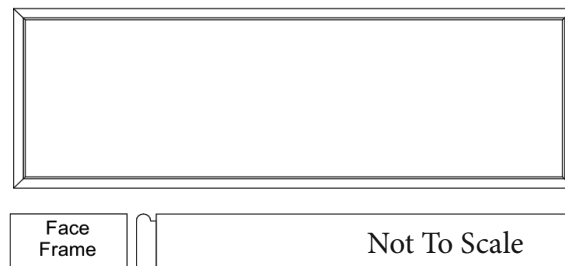

FOR USE
PRIMARILY WITH
HATTERAS
DOOR STYLE

DOOR STYLES

TAILORMADE - Custom Doors

INSIDE EDGES - STANDARD

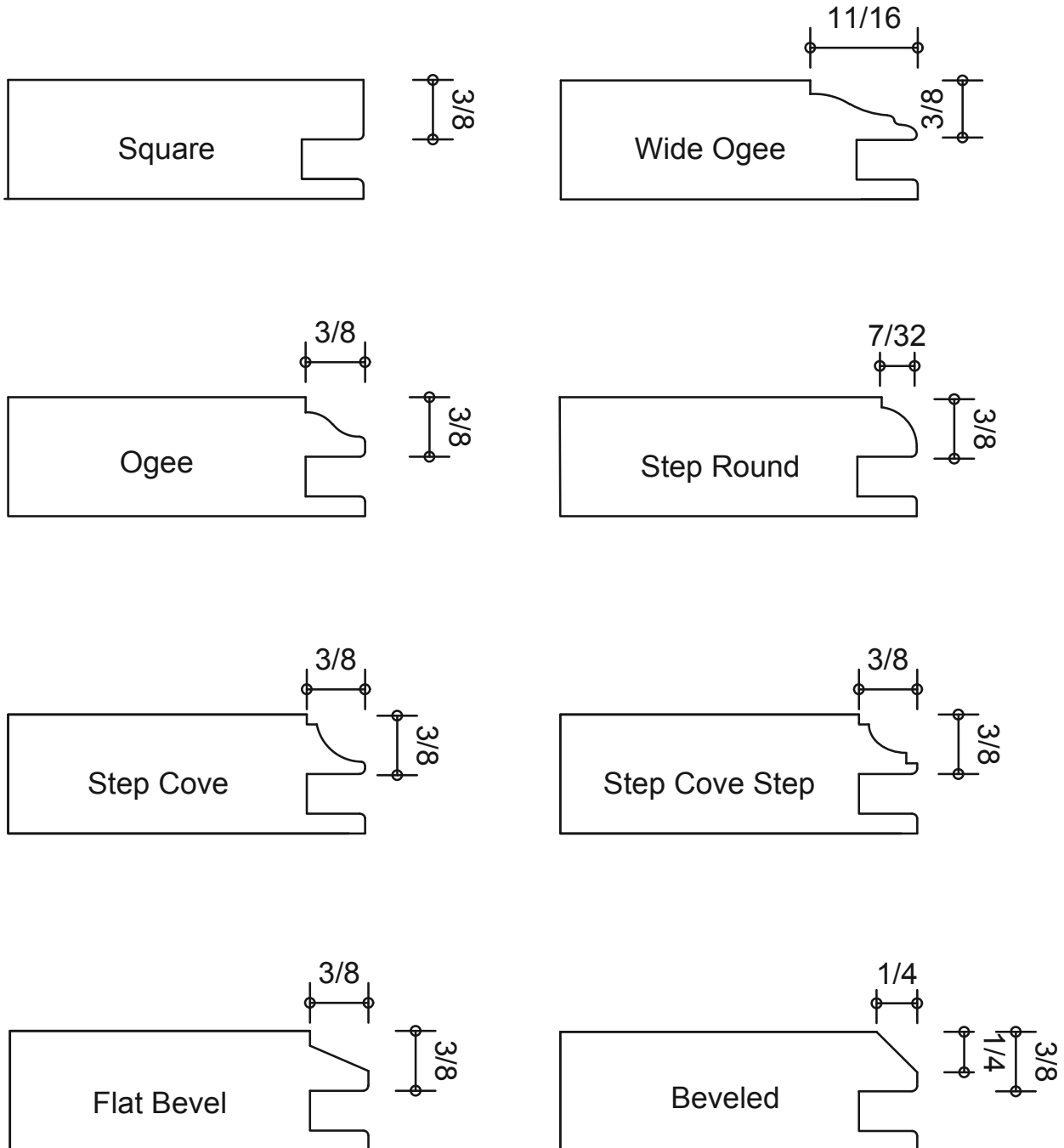

DOOR STYLES

TAILORMADE - Custom Doors

INSIDE EDGES - APPLIED MOLDINGS

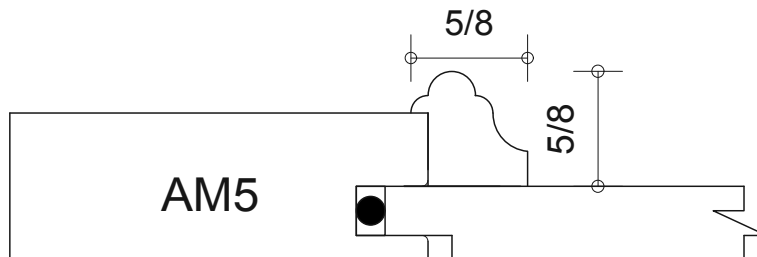
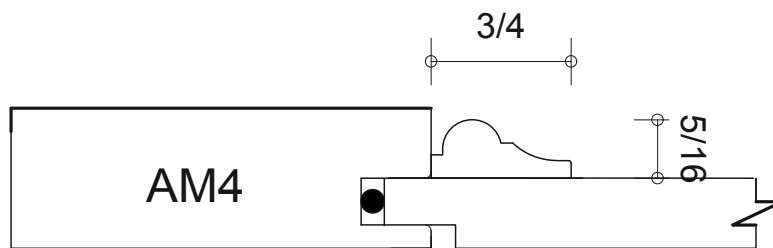
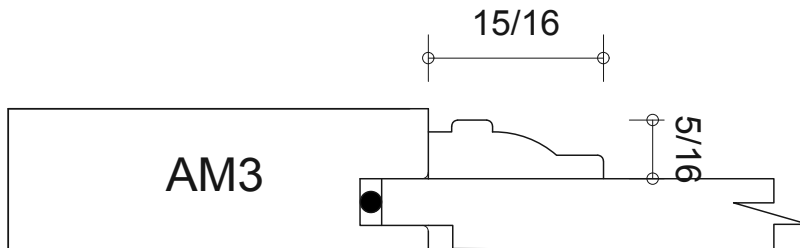
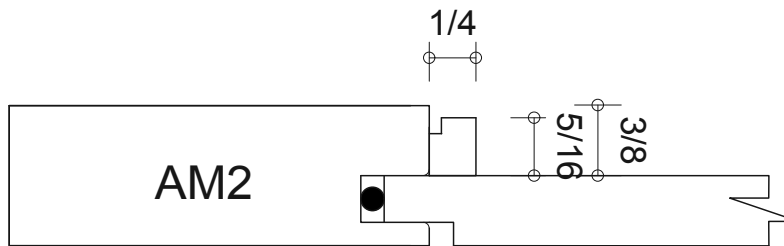
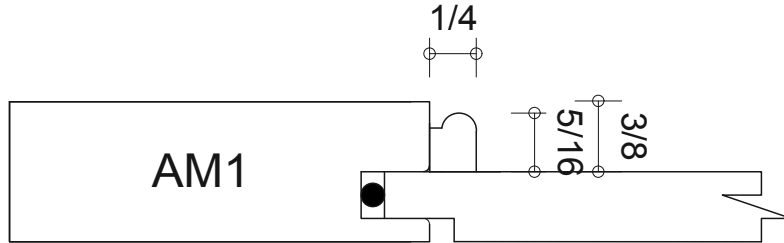

DOOR STYLES

TAILORMADE - Custom Doors

INSIDE EDGES - APPLIED MOLDINGS

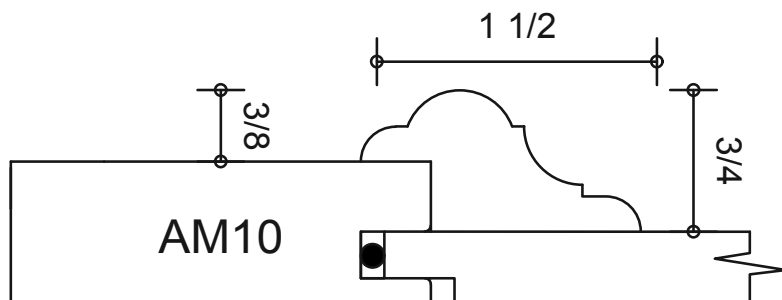
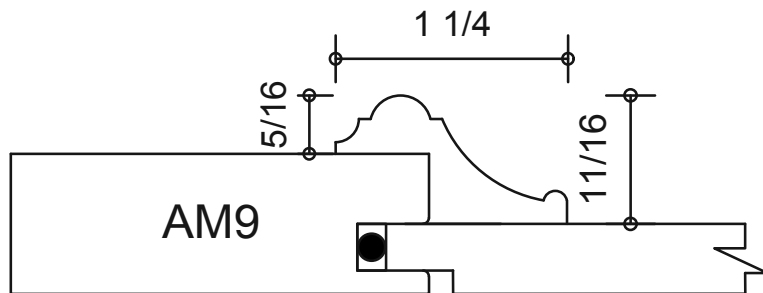
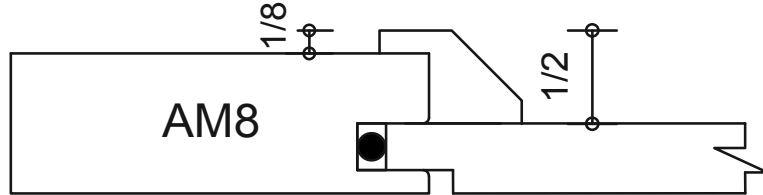
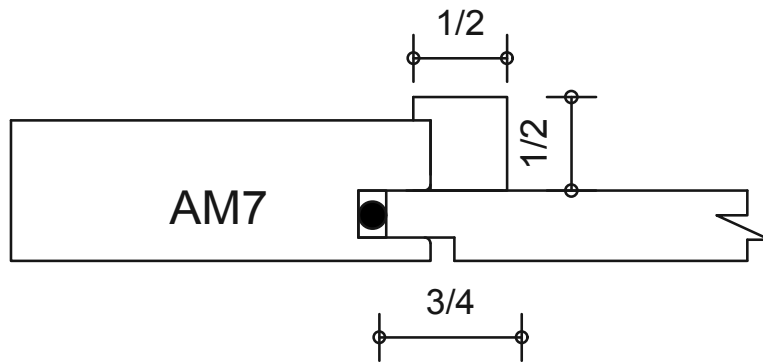
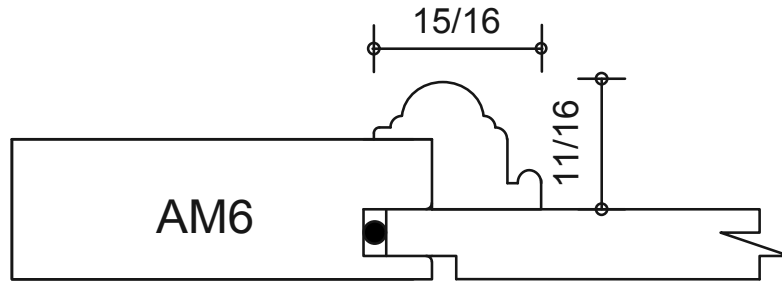

DOOR STYLES

TAILORMADE - Custom Doors

INSIDE EDGES - APPLIED MOLDINGS

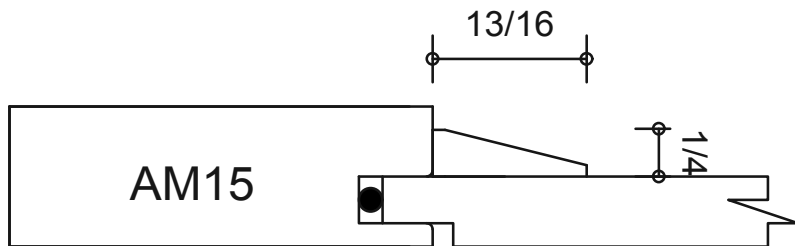
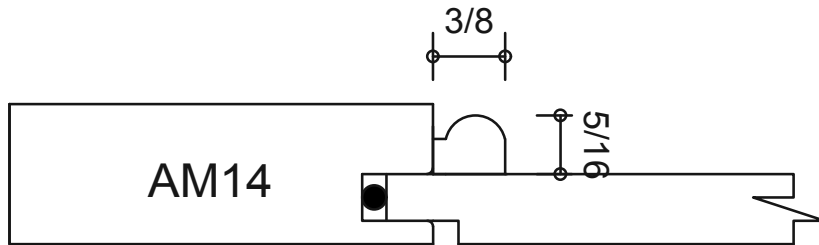
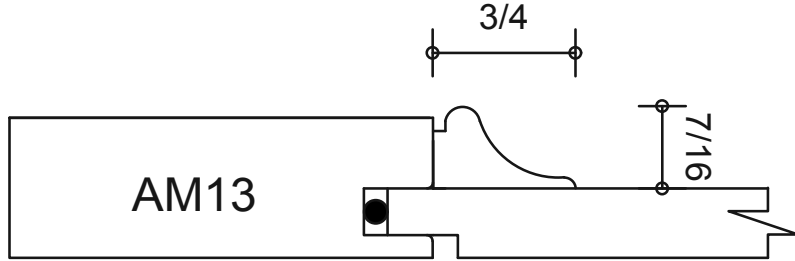

DOOR STYLES

TAILORMADE - Custom Doors

PANEL RAISES

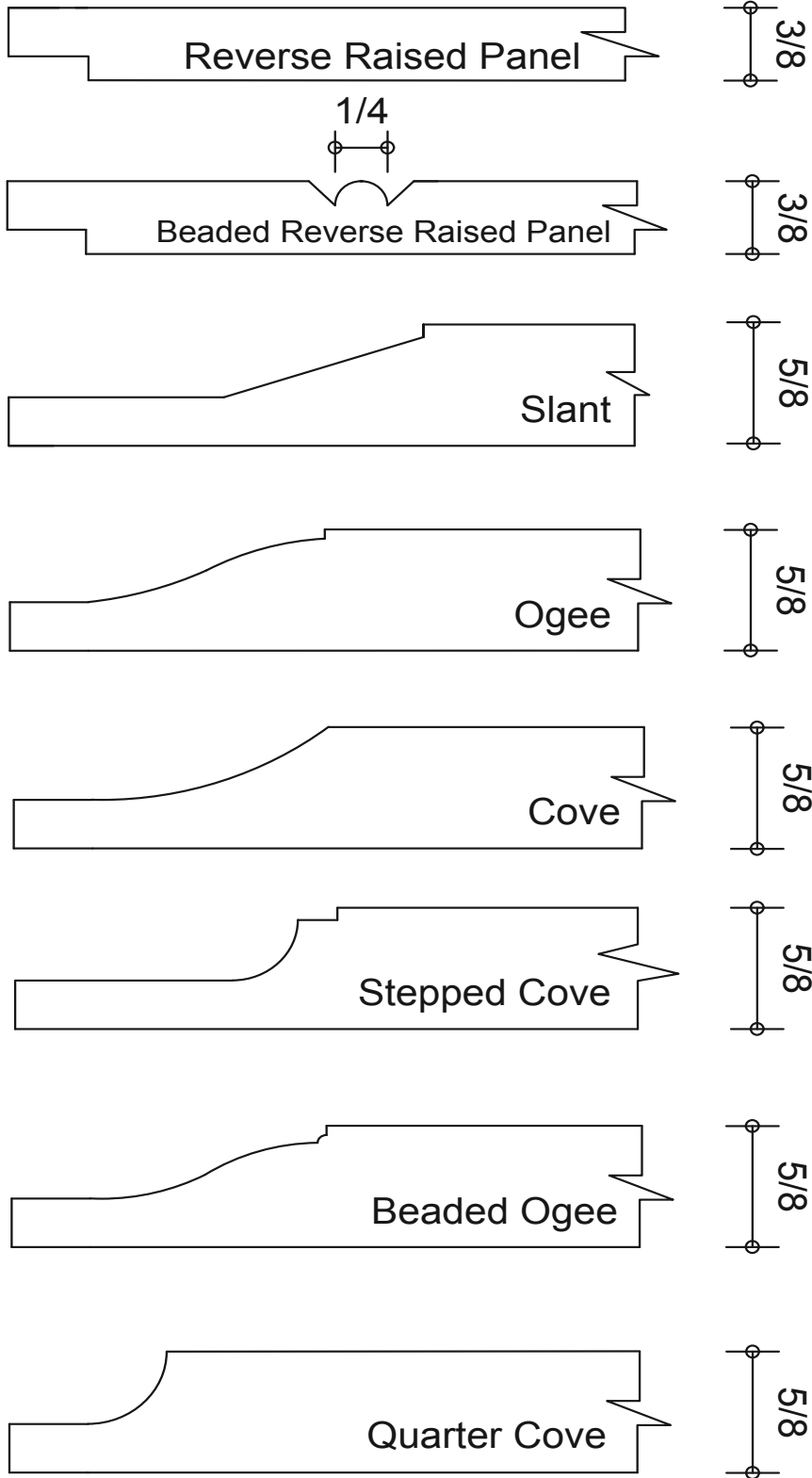

DOOR STYLES

TAILORMADE - Custom Doors

OUTSIDE EDGE PROFILES

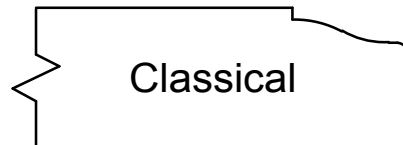
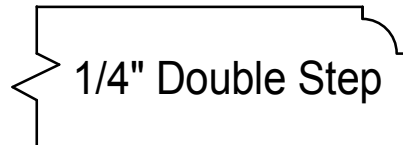
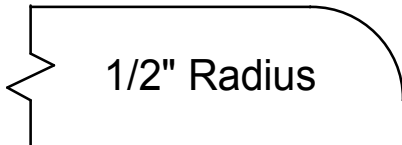
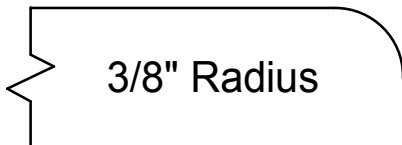
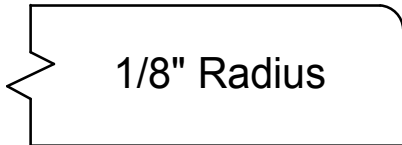

DOOR STYLES

TAILORMADE

Custom Door Program

UPCHARGE PRICING

Sometimes one of our standard doorstyles is not quite what your customer is looking for, that's where the Tailormade Door Program comes in. Any variation from the door specs found in the standard door section of the catalog, makes a door a Tailormade door. For example: If your customer wants a Tuscany Hill Door, but instead of the Large Ogee Outside Edge they prefer the Classical Edge, then you would use the Tailormade Door Program and add the price options below.

TAILOR MADE OPTIONS	UPCHARGE PER DOOR OR DRAWER FRONT
Any Tailormade Option	\$50
Tailormade - with AM1 applied	\$134
Tailormade - with AM2 applied	\$217
Tailormade - with AM3 applied	\$134
Tailormade - with AM4 applied	\$134
Tailormade - with AM5 applied	\$217
Tailormade - with AM6 applied	\$217
Tailormade - with AM7 applied	\$217
Tailormade - with AM8 applied	\$217
Tailormade - with AM9 applied	\$217
Tailormade - with AM10 applied	\$217
Beaded Reverse Raised Panel	\$134

DOOR STYLES

MULLION DOORS

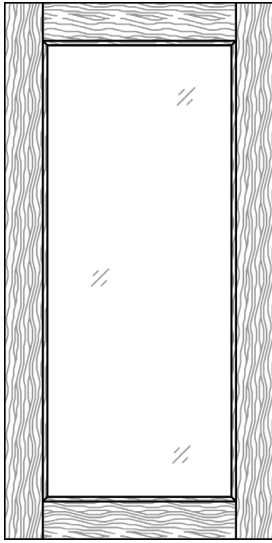

MD100 - FRAME ONLY DOOR

- List Price Per Door No Charge
- Glass Not Included
- Includes Clear Rubber Glass Retainer
- Limitations apply to this mullion pattern for applied molding doorstyles. Request Quote.

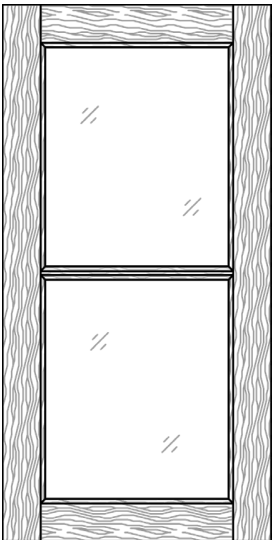

MD101 DOOR

- List Price Per Door \$290
- Glass Not Included
- Includes Clear Rubber Glass Retainer
- Lites are divided equally in height unless specified otherwise.
- Limitations apply to this mullion pattern for applied molding doorstyles. Request Quote.
- Doors over 60" Tall or over 14 square feet may incur additional charges. Request Quote.

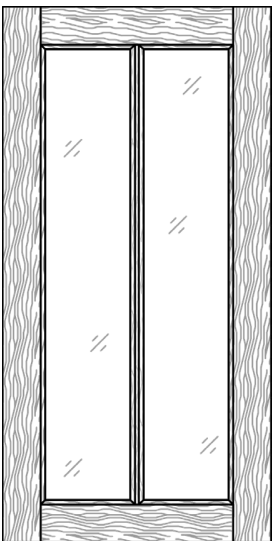

MD102 DOOR

- List Price Per Door \$290
- Glass Not Included
- Includes Clear Rubber Glass Retainer
- Lites are divided equally in width.
- Limitations apply to this mullion pattern for applied molding doorstyles. Request Quote.
- Doors over 60" Tall or over 14 square feet may incur additional charges. Request Quote.

DOOR STYLES

MULLION DOORS

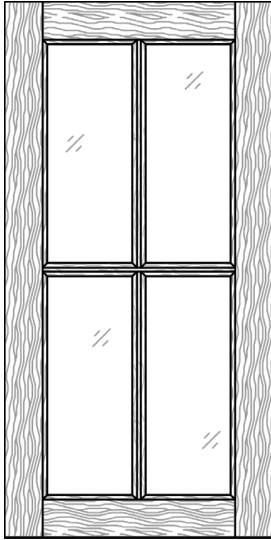

MD103 DOOR

- List Price Per Door \$290
- Glass Not Included
- Includes Clear Rubber Glass Retainer
- Limitations apply to this mullion pattern for applied molding doorstyles. Request Quote.
- Doors over 60" Tall or over 14 square feet may incur additional charges. Request Quote.

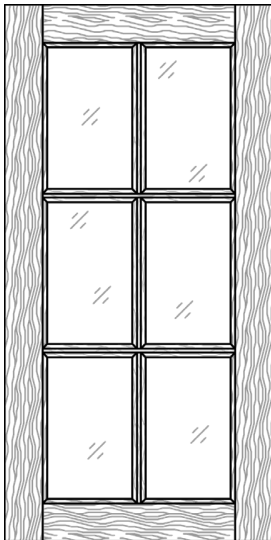

MD104 DOOR

- List Price Per Door \$400
- Glass Not Included
- Includes Clear Rubber Glass Retainer
- Limitations apply to this mullion pattern for applied molding doorstyles. Request Quote.
- Doors over 60" Tall or over 14 square feet may incur additional charges. Request Quote.

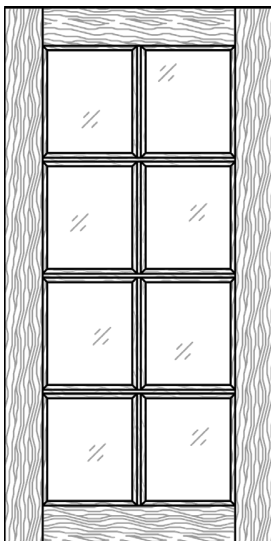

MD105 DOOR

- List Price Per Door \$400
- Glass Not Included
- Includes Clear Rubber Glass Retainer
- Limitations apply to this mullion pattern for applied molding doorstyles. Request Quote.
- Doors over 60" Tall or over 14 square feet may incur additional charges. Request Quote.

DOOR STYLES

MULLION DOORS

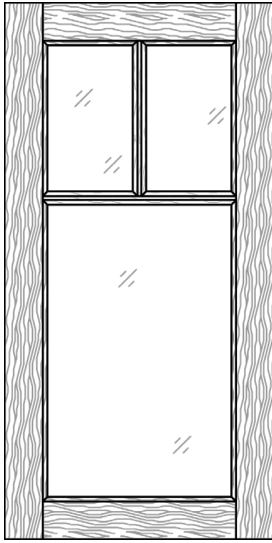

MD106 DOOR

- List Price Per Door \$290
- Glass Not Included
- Includes Clear Rubber Glass Retainer
- Minimum Height of Top Light Pattern is 1" High
- Top Lites Will Be Equal Width
- Limitations apply to this mullion pattern for applied molding doorstyles. Request Quote.
- Doors over 60" Tall or over 14 square feet may incur additional charges. Request Quote.

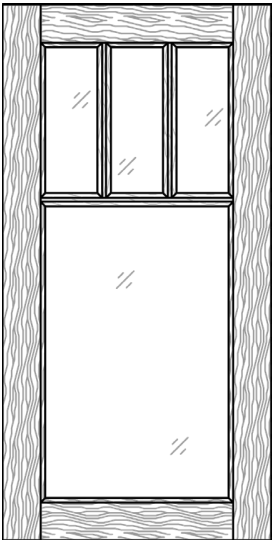

MD107 DOOR

- List Price Per Door \$290
- Glass Not Included
- Includes Clear Rubber Glass Retainer
- Minimum Height of Top Light Pattern is 1" High
- Top Lites Will Be Equal Width
- Limitations apply to this mullion pattern for applied molding doorstyles. Request Quote.
- Doors over 60" Tall or over 14 square feet may incur additional charges. Request Quote.

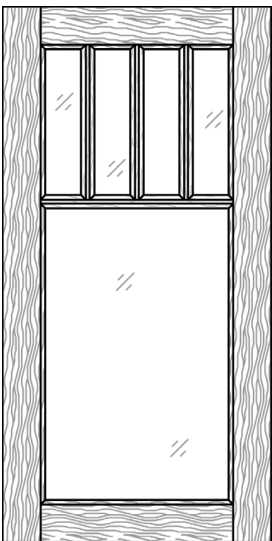

MD108 DOOR

- List Price Per Door \$400
- Glass Not Included
- Includes Clear Rubber Glass Retainer
- Minimum Height of Top Light Pattern is 1" High
- Top Lites Will Be Equal Width
- Limitations apply to this mullion pattern for applied molding doorstyles. Request Quote.
- Doors over 60" Tall or over 14 square feet may incur additional charges. Request Quote.

DOOR STYLES

MULLION DOORS

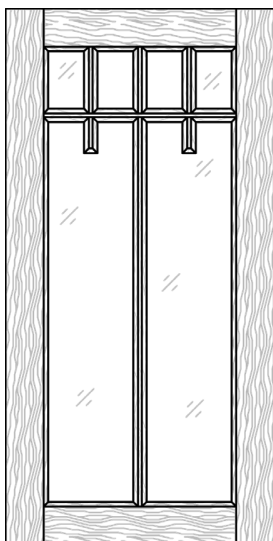

MD109 DOOR

- List Price Per Door \$400
- Glass Not Included
- Includes Clear Rubber Glass Retainer
- Minimum width 12" - Based On 2 1/4" Stiles
- Short Pieces will be half the length of the vertical pience above and will have a "fenale" cut on the ends.
- Limitations apply to this mullion pattern for applied molding doorstyles. Request Quote.
- Doors over 60" Tall or over 14 square feet may incur additional charges. Request Quote.

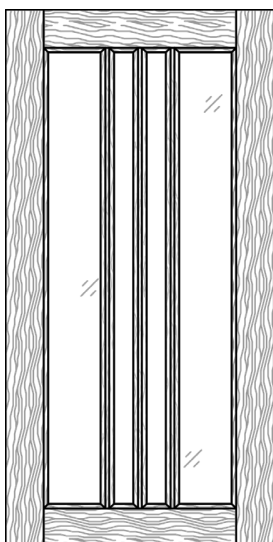

MD110 DOOR

- List Price Per Door \$290
- Glass Not Included
- Includes Clear Rubber Glass Retainer
- Minimum width 12" - Based On 2 1/4" Stiles
- Vertical Dividers are spaced 1" apart with the remainder of the space divided equally .
- Doors over 60" Tall or over 14 square feet may incur additional charges. Request Quote.

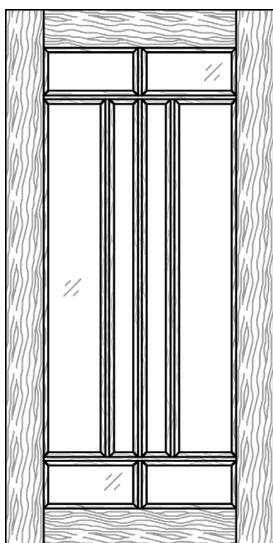

MD111 DOOR

- List Price Per Door \$400
- Glass Not Included
- Includes Clear Rubber Glass Retainer
- Minimum width 12" - Based On 2 1/4" Stiles
- Vertical Dividers are spaced 1" apart with the remainder of the space divided equally .
- Opening height of the top and bottom lites must be specified and will be equal.
- Limitations apply to this mullion pattern for applied molding doorstyles. Request Quote.
- Doors over 60" Tall or over 14 square feet may incur additional charges. Request Quote.

DOOR STYLES

MULLION DOORS

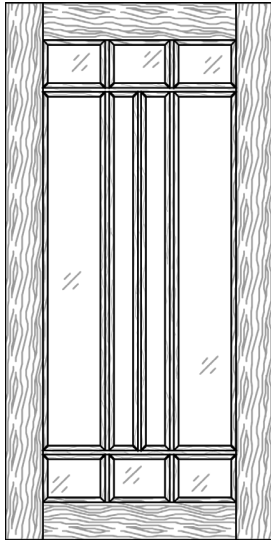

MD112 DOOR

- List Price Per Door \$485
- Glass Not Included
- Includes Clear Rubber Glass Retainer
- Minimum width 12" - Based On 2 1/4" Stiles
- Specify Width and Height of Corner Lites.
- Minimum width of Corner Lites is 1" x 1"
- Vertical Dividers are spaced 1" apart with the remainder of the space divided equally .
- Limitations apply to this mullion pattern for applied molding doorstyles. Request Quote.
- Doors over 60" Tall or over 14 square feet may incur additional charges. Request Quote.

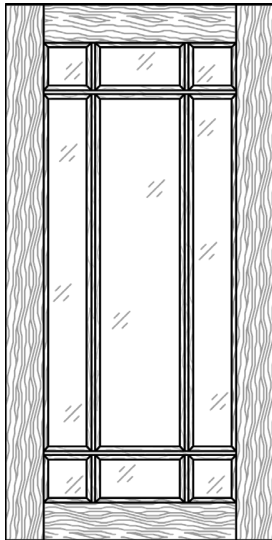

MD114 DOOR

- List Price Per Door \$485
- Glass Not Included
- Includes Clear Rubber Glass Retainer
- Minimum width 12" - Based On 2 1/4" Stiles
- Specify width and height of corner lites
- Minimum size of corner lites is 1" x 1"
- Limitations apply to this mullion pattern for applied molding doorstyles. Request Quote.
- Doors over 60" Tall or over 14 square feet may incur additional charges. Request Quote.

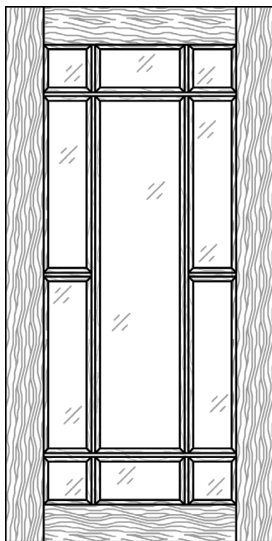

MD115 DOOR

- List Price Per Door \$485
- Glass Not Included
- Includes Clear Rubber Glass Retainer
- Minimum width 12" - Based On 2 1/4" Stiles
- Specify width and height of corner lites
- Minimum size of corner lites is 1" x 1"
- Limitations apply to this mullion pattern for applied molding doorstyles. Request Quote.
- Doors over 60" Tall or over 14 square feet may incur additional charges. Request Quote.

DOOR STYLES

MULLION DOORS

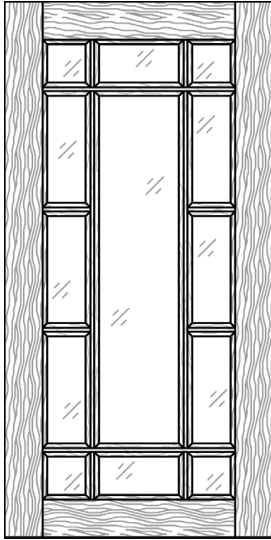

MD116 DOOR

- List Price Per Door \$560
- Glass Not Included
- Includes Clear Rubber Glass Retainer
- Minimum width 12" - Based On 2 1/4" Stiles
- Specify width and height of corner lites
- Minimum size of corner lites is 1" x 1"
- Limitations apply to this mullion pattern for applied molding doorstyles. Request Quote.
- Doors over 60" Tall or over 14 square feet may incur additional charges. Request Quote.

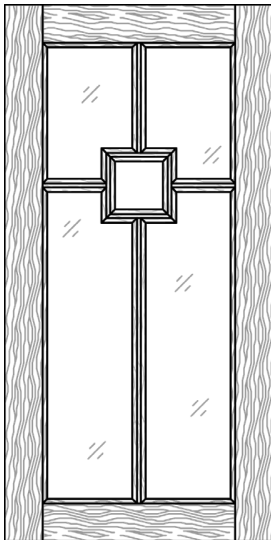

MD117 DOOR

- List Price Per Door \$860
- Glass Not Included
- Includes Clear Rubber Glass Retainer
- Minimum width 12" - Based On 2 1/4" Stiles
- Minimum Height 12" - Based On 2 1/4" Stiles
- Center Square is Fixed Dimension at 2.5" x 2.5"
- Doors over 60" Tall or over 14 square feet may incur additional charges. Request Quote.

DOOR STYLES

MULLION DOORS

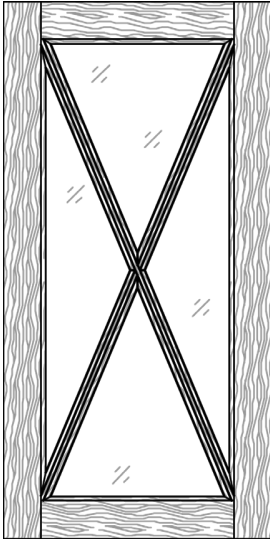

MD200 DOOR

- List Price Per Door \$1320
- Glass Not Included
- Includes Clear Rubber Glass Retainer
- Minimum width 12" - Based On 2 1/4" Stiles
- Limitations apply to this mullion pattern for applied molding doorstyles. Request Quote.
- Doors over 60" Tall or over 14 square feet may incur additional charges. Request Quote.

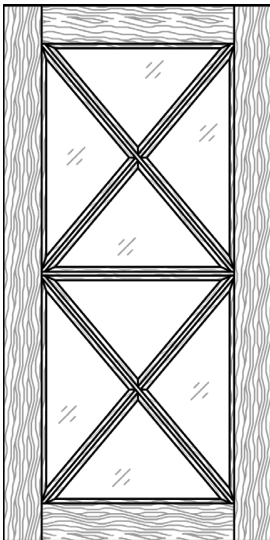

MD201 DOOR

- List Price Per Door \$2315
- Glass Not Included
- Includes Clear Rubber Glass Retainer
- Minimum width 12" - Based On 2 1/4" Stiles
- Limitations apply to this mullion pattern for applied molding doorstyles. Request Quote.
- Doors over 60" Tall or over 14 square feet may incur additional charges. Request Quote.

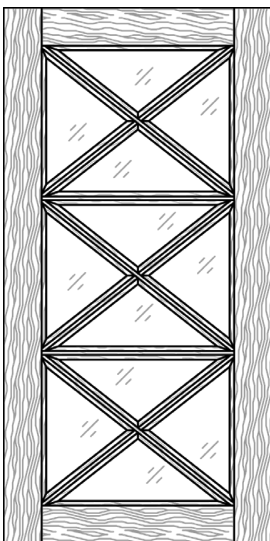

MD202 DOOR

- List Price Per Door \$3395
- Glass Not Included
- Includes Clear Rubber Glass Retainer
- Minimum width 12" - Based On 2 1/4" Stiles
- In order to achieve the best look - the height of the door must be at least twice the height.
- Limitations apply to this mullion pattern for applied molding doorstyles. Request Quote.
- Doors over 60" Tall or over 14 square feet may incur additional charges. Request Quote.

DOOR STYLES

MULLION DOORS

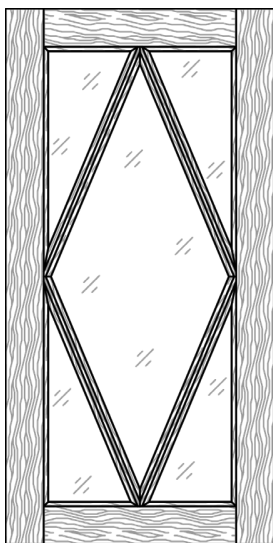

MD300 DOOR

- List Price Per Door \$1175
- Glass Not Included
- Includes Clear Rubber Glass Retainer
- Minimum width 12" - Based on 2 1/4" Stiles.
- Limitations apply to this mullion pattern for applied molding doorstyles. Request Quote.
- Doors over 60" Tall or over 14 square feet may incur additional charges. Request Quote.

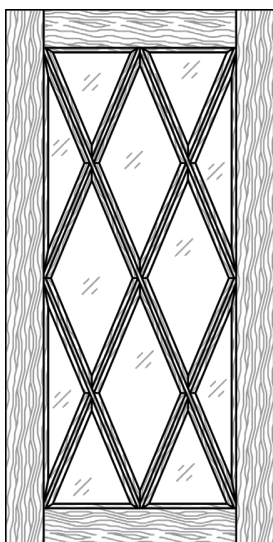

MD301 DOOR

- List Price Per Door \$3125
- Glass Not Included
- Includes Clear Rubber Glass Retainer
- Minimum width 12" - Based On 2 1/4" Stiles
- Limitations apply to this mullion pattern for applied molding doorstyles. Request Quote.
- Doors over 60" Tall or over 14 square feet may incur additional charges. Request Quote.

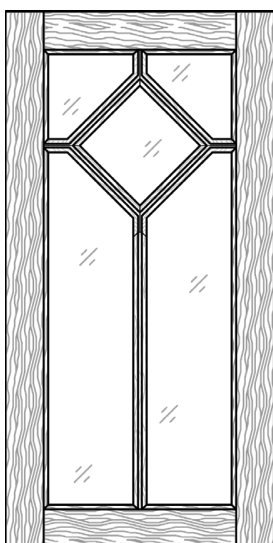

MD302 DOOR

- List Price Per Door \$1175
- Glass Not Included
- Includes Clear Rubber Glass Retainer
- Minimum width 12" - Based On 2 1/4" Stiles
- Limitations apply to this mullion pattern for applied molding doorstyles. Request Quote.
- Doors over 60" Tall or over 14 square feet may incur additional charges. Request Quote.

DOOR STYLES

MULLION DOORS

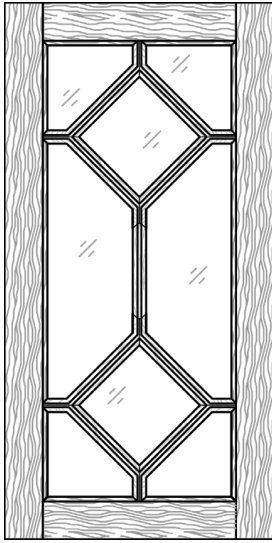

MD303 DOOR

- List Price Per Door \$1725
- Glass Not Included
- Includes Clear Rubber Glass Retainer
- Minimum width 12" - Based On 2 1/4" Stiles
- Limitations apply to this mullion pattern for applied molding doorstyles. Request Quote.
- Doors over 60" Tall or over 14 square feet may incur additional charges. Request Quote.

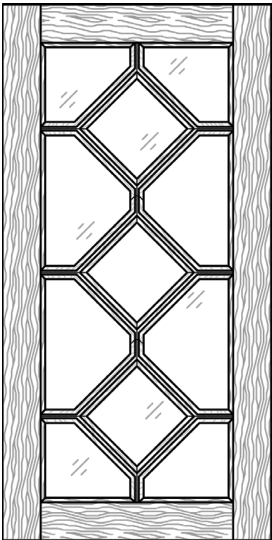

MD304 DOOR

- List Price Per Door \$2475
- Glass Not Included
- Includes Clear Rubber Glass Retainer
- Minimum width 12" - Based On 2 1/4" Stiles
- Limitations apply to this mullion pattern for applied molding doorstyles. Request Quote.
- Doors over 60" Tall or over 14 square feet may incur additional charges. Request Quote.

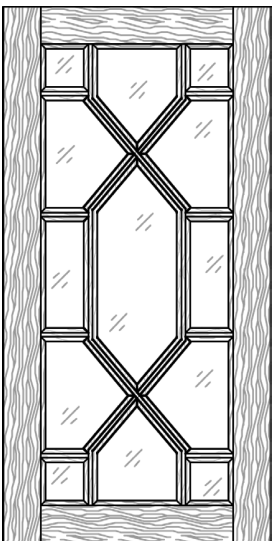

MD305 DOOR

- List Price Per Door \$3555
- Glass Not Included
- Includes Clear Rubber Glass Retainer
- Minimum width 12" - Based On 2 1/4" Stiles
- Minimum height must be two times the width of the door.
- Limitations apply to this mullion pattern for applied molding doorstyles. Request Quote.
- Minimum size of corner lites is 1" x 1"
- Doors over 60" Tall or over 14 square feet may incur additional charges. Request Quote.

DOOR STYLES

MULLION DOORS

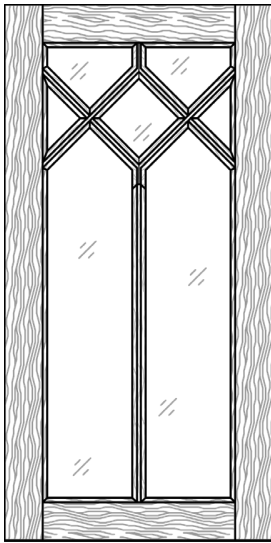

MD306 DOOR

- List Price Per Door \$1175
- Glass Not Included
- Includes Clear Rubber Glass Retainer
- Minimum width 12" - Based On 2 1/4" Stiles
- Limitations apply to this mullion pattern for applied molding doorstyles. Request Quote.
- Doors over 60" Tall or over 14 square feet may incur additional charges. Request Quote.

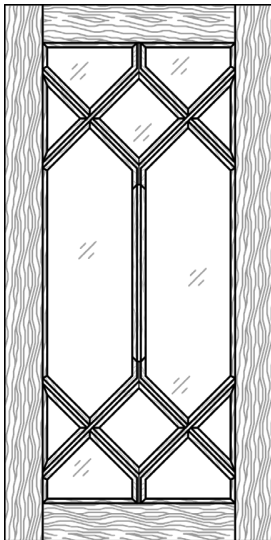

MD307 DOOR

- List Price Per Door \$1320
- Glass Not Included
- Includes Clear Rubber Glass Retainer
- Minimum width 12" - Based On 2 1/4" Stiles
- Limitations apply to this mullion pattern for applied molding doorstyles. Request Quote.
- Doors over 60" Tall or over 14 square feet may incur additional charges. Request Quote.

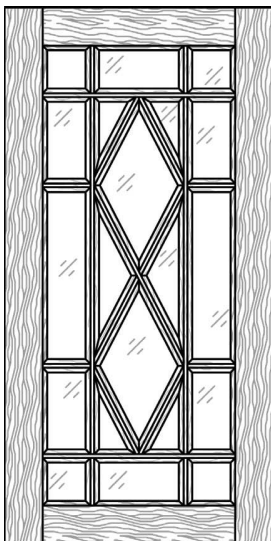

MD308 DOOR

- List Price Per Door \$2085
- Glass Not Included
- Includes Clear Rubber Glass Retainer
- Minimum width 12" - Based On 2 1/4" Stiles
- Limitations apply to this mullion pattern for applied molding doorstyles. Request Quote.
- Specify width and height of corner lites
- Minimum size of corner lites is 1" x 1"
- Doors over 60" Tall or over 14 square feet may incur additional charges. Request Quote.

DOOR STYLES

MULLION DOORS

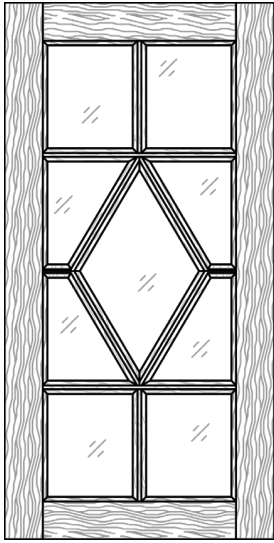

MD309 DOOR

- List Price Per Door \$1175
- Glass Not Included
- Includes Clear Rubber Glass Retainer
- Minimum width 12" - Based On 2 1/4" Stiles
- Height must be greater than the width.
- Doors over 60" Tall or over 14 square feet may incur additional charges. Request Quote.

DOOR STYLES

MULLION DOORS

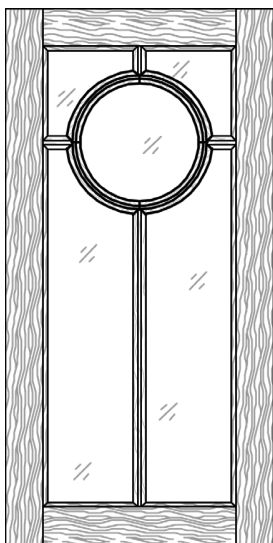

MD400 DOOR

- List Price Per Door \$1490
- Glass Not Included
- Includes Clear Rubber Glass Retainer
- Minimum width 12" - Based On 2 1/4" Stiles
- Vertical strip at top and horizontal strips are fixed at 1" long.
- Minimum height must be greater than the width.
- Limitations apply to this mullion pattern for applied molding doorstyles. Request Quote.
- Doors over 60" Tall or over 14 square feet may incur additional charges. Request Quote.

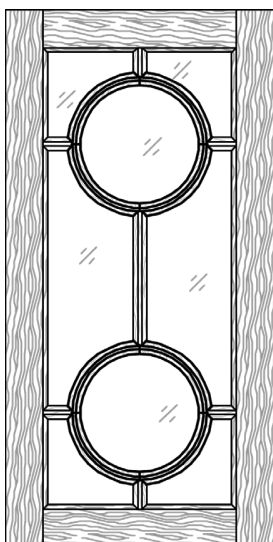

MD401 DOOR

- List Price Per Door \$2315
- Glass Not Included
- Includes Clear Rubber Glass Retainer
- Minimum width 12" - Based On 2 1/4" Stiles
- Vertical strip at top and bottom and horizontal strips are fixed at 1" long.
- Minimum Height must be 1 3/4 greater than the width.
- Limitations apply to this mullion pattern for applied molding doorstyles. Request Quote.
- Doors over 60" Tall or over 14 square feet may incur additional charges. Request Quote.

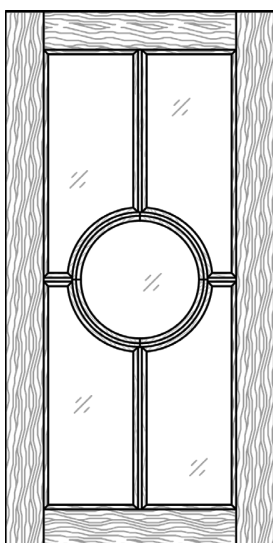

MD402 DOOR

- List Price Per Door \$1490
- Glass Not Included
- Includes Clear Rubber Glass Retainer
- Minimum width 12" - Based On 2 1/4" Stiles
- Minimum height of door must be equal or greater than the width.
- Horizontal mullion strips are fixed at 1" long.
- Limitations apply to this mullion pattern for applied molding doorstyles. Request Quote.
- Doors over 60" Tall or over 14 square feet may incur additional charges. Request Quote.

DOOR STYLES

MULLION DOORS

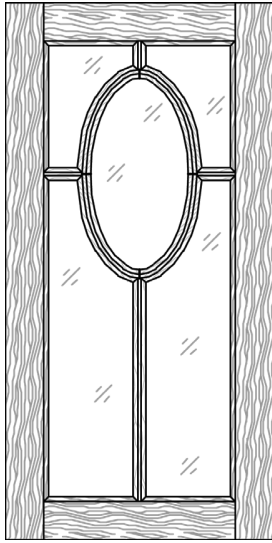

MD403 DOOR

- List Price Per Door \$1490
- Glass Not Included
- Includes Clear Rubber Glass Retainer
- Minimum Width 12" - Based On 2 1/4" Stiles
- Minimum Height 12" - Based On 2 1/4" Stiles
- Limitations apply to this mullion pattern for applied molding doorstyles. Request Quote.
- Doors over 60" Tall or over 14 square feet may incur additional charges. Request Quote.

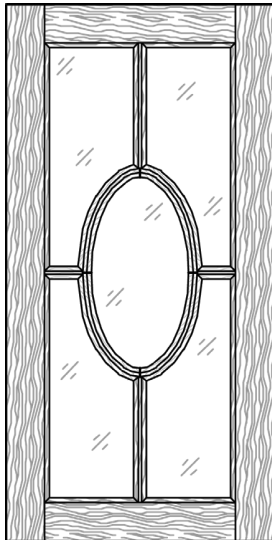

MD404 DOOR

- List Price Per Door \$1490
- Glass Not Included
- Includes Clear Rubber Glass Retainer
- Minimum Width 12" - Based On 2 1/4" Stiles
- Minimum Height 12"
- Limitations apply to this mullion pattern for applied molding doorstyles. Request Quote.
- Doors over 60" Tall or over 14 square feet may incur additional charges. Request Quote.

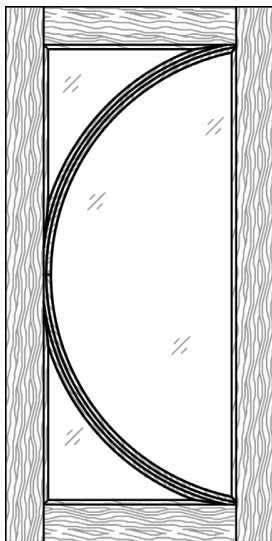

MD405 DOOR

- List Price Per Door \$1320
- Glass Not Included
- Includes Clear Rubber Glass Retainer
- Minimum Width 12" - Based On 2 1/4" Stiles
- Limitations apply to this mullion pattern for applied molding doorstyles. Request Quote.
- Doors over 60" Tall or over 14 square feet may incur additional charges. Request Quote.

DOOR STYLES

MULLION DOORS

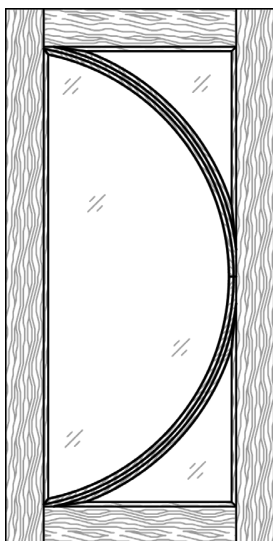

MD406 DOOR

- List Price Per Door \$1320
- Glass Not Included
- Includes Clear Rubber Glass Retainer
- Minimum Width 12" - Based On 2 1/4" Stiles
- Limitations apply to this mullion pattern for applied molding doorstyles. Request Quote.
- Doors over 60" Tall or over 14 square feet may incur additional charges. Request Quote.

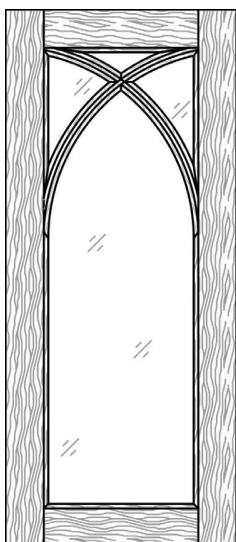

MD407 DOOR

- List Price Per Door \$1490
- Glass Not Included
- Includes Clear Rubber Glass Retainer
- Minimum width 12" - Based On 2 1/4" Stiles
- Minimum Height must be 1.5 times the width plus the top and bottom rail.
- Limitations apply to this mullion pattern for applied molding doorstyles. Request Quote.
- Doors over 60" Tall or over 14 square feet may incur additional charges. Request Quote.

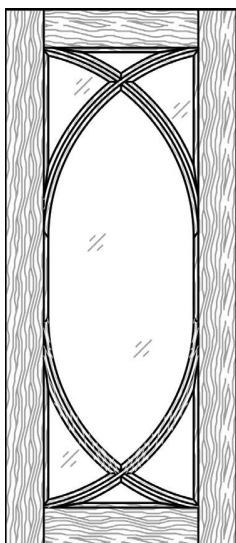

MD408 DOOR

- List Price Per Door \$2475
- Glass Not Included
- Includes Clear Rubber Glass Retainer
- Minimum width 12" - Based On 2 1/4" Stiles
- Minimum Height must be 2 times the width plus the top and bottom rail.
- Limitations apply to this mullion pattern for applied molding doorstyles. Request Quote.
- Doors over 60" Tall or over 14 square feet may incur additional charges. Request Quote.

DOOR STYLES

MULLION DOORS

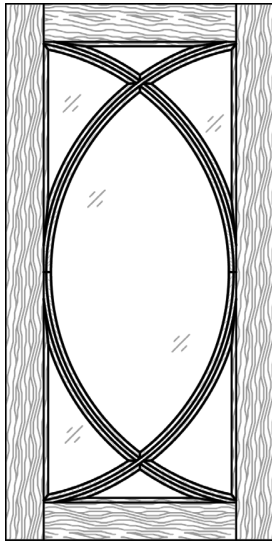

MD409 DOOR

- List Price Per Door \$2675
- Glass Not Included
- Includes Clear Rubber Glass Retainer
- Minimum width 12" - Based On 2 1/4" Stiles
- In order to achieve the best look - the height of the door must be at least twice the height.
- Limitations apply to this mullion pattern for applied molding doorstyles. Request Quote.

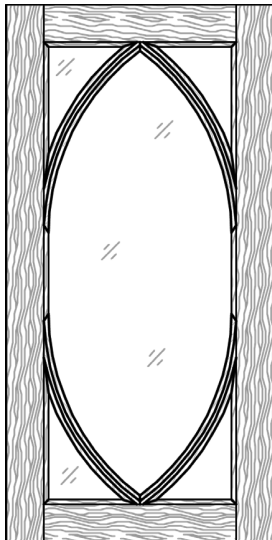

MD410 DOOR

- List Price Per Door \$1725
- Glass Not Included
- Includes Clear Rubber Glass Retainer
- Minimum width 12" - Based On 2 1/4" Stiles
- Limitations apply to this mullion pattern for applied molding doorstyles. Call for details.

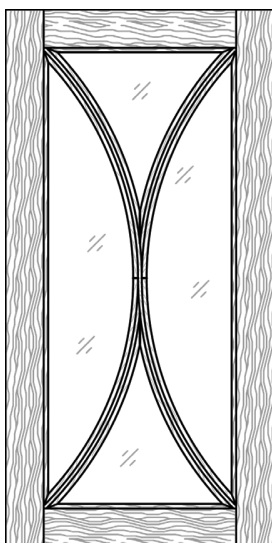

MD411 DOOR

- List Price Per Door \$1885
- Glass Not Included
- Includes Clear Rubber Glass Retainer
- Minimum width 12" - Based On 2 1/4" Stiles
- Minimum height must be greater than the width.
- Limitations apply to this mullion pattern for applied molding doorstyles. Call for details.

DOOR STYLES

MULLION DOORS

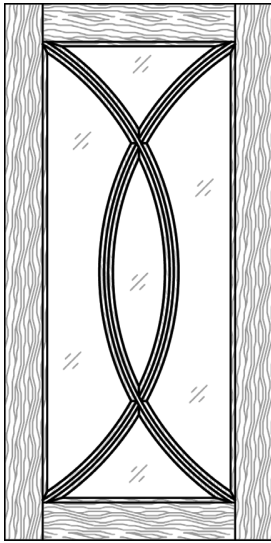

MD412 DOOR

- List Price Per Door \$2085
- Glass Not Included
- Includes Clear Rubber Glass Retainer
- Minimum width 12" - Based On 2 1/4" Stiles
- Minimum height must be 1.5 times the width.
- Limitations apply to this mullion pattern for applied molding doorstyles. Request Quote.

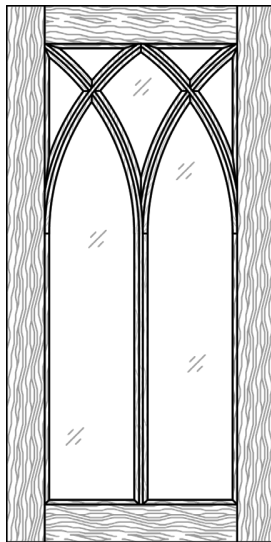

MD413 DOOR

- List Price Per Door \$2315
- Glass Not Included
- Includes Clear Rubber Glass Retainer
- Minimum width 12" - Based On 2 1/4" Stiles
- Height must be equal to or greater than the width to allow one pattern on top & bottom.
- Limitations apply to this mullion pattern for applied molding doorstyles. Call for details.

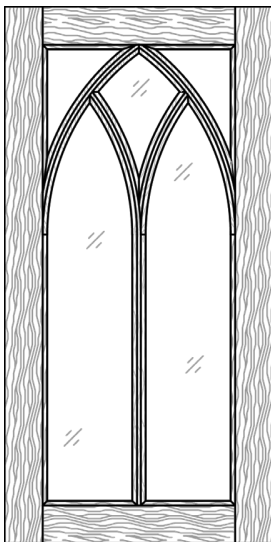

MD414 DOOR

- List Price Per Door \$1885
- Glass Not Included
- Includes Clear Rubber Glass Retainer
- Minimum width 12" - Based On 2 1/4" Stiles
- Limitations apply to this mullion pattern for applied molding doorstyles. Call for details.

DOOR STYLES

MULLION DOORS

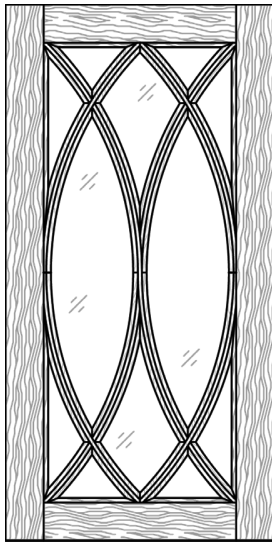

MD415 DOOR

- List Price Per Door \$3910
- Glass Not Included
- Includes Clear Rubber Glass Retainer
- Minimum width 12" - Based On 2 1/4" Stiles
- Minimum height must be at least 1.5" times the width.
- Limitations apply to this mullion pattern for applied molding doorstyles. Request Quote.
- Doors over 60" Tall or over 14 square feet may incur additional charges. Request Quote.

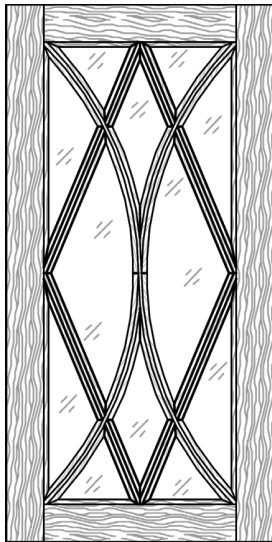

MD416 DOOR

- List Price Per Door \$3910
- Glass Not Included
- Includes Clear Rubber Glass Retainer
- Minimum width 12" - Based On 2 1/4" Stiles
- Minimum height must be at least 1.5" times the width.
- Limitations apply to this mullion pattern for applied molding doorstyles. Request Quote.
- Doors over 60" Tall or over 14 square feet may incur additional charges. Request Quote.

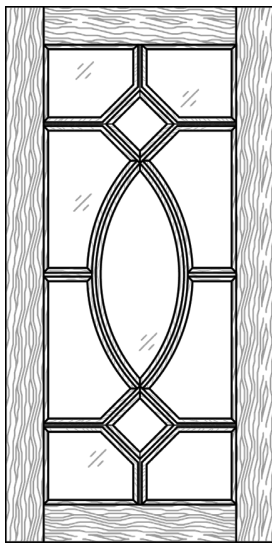

MD417 DOOR

- List Price Per Door \$2675
- Glass Not Included
- Includes Clear Rubber Glass Retainer
- Minimum width 12" - Based On 2 1/4" Stiles
- Limitations apply to this mullion pattern for applied molding doorstyles. Request Quote.
- Diamonds are fixed at 2" x 2"
- Minimum height must be 2 times larger than the width of the door.
- Doors over 60" Tall or over 14 square feet may incur additional charges. Request Quote.

DOOR STYLES

MULLION DOORS

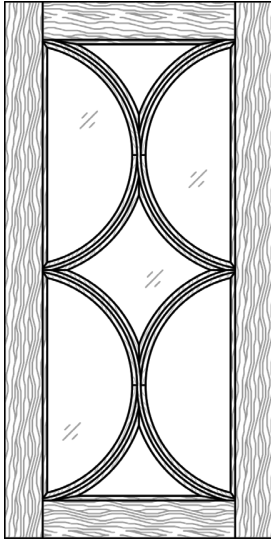

MD418 DOOR

- List Price Per Door \$3125
- Glass Not Included
- Includes Clear Rubber Glass Retainer
- Minimum width 12" - Based On 2 1/4" Stiles
- Minimum height must be two times greater than the width.
- Limitations apply to this mullion pattern for applied molding doorstyles. Request Quote.
- Doors over 60" Tall or over 14 square feet may incur additional charges. Request Quote.

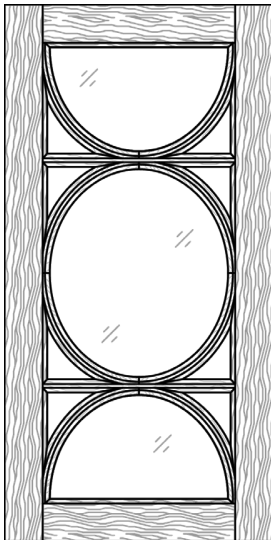

MD419 DOOR

- List Price Per Door \$3125
- Glass Not Included
- Includes Clear Rubber Glass Retainer
- Minimum width 12" - Based On 2 1/4" Stiles
- In order to achieve the best look - the height of the door must be at least twice the height.
- Limitations apply to this mullion pattern for applied molding doorstyles. Request Quote.
- Doors over 60" Tall or over 14 square feet may incur additional charges. Request Quote.

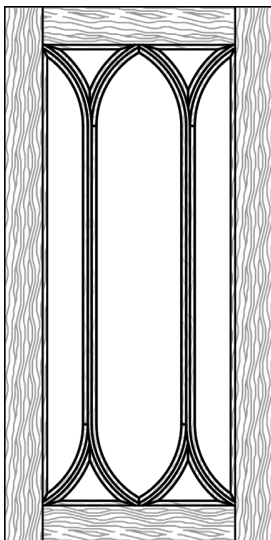

MD420 DOOR

- List Price Per Door \$3125
- Glass Not Included
- Includes Clear Rubber Glass Retainer
- Minimum width 12" - Based On 2 1/4" Stiles
- Minimum height must be equal to or greater than the width.
- Limitations apply to this mullion pattern for applied molding doorstyles. Request Quote.
- Doors over 60" Tall or over 14 square feet may incur additional charges. Request Quote.

DOOR STYLES

MULLION DOORS

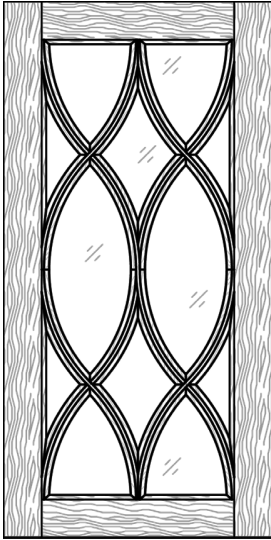

MD421 DOOR

- List Price Per Door \$4330
- Glass Not Included
- Includes Clear Rubber Glass Retainer
- Minimum width 12" - Based On 2 1/4" Stiles
- In order to achieve the best look - the height of the door must be at least twice the height.
- Limitations apply to this mullion pattern for applied molding doorstyles. Request Quote.
- Doors over 60" Tall or over 14 square feet may incur additional charges. Request Quote.

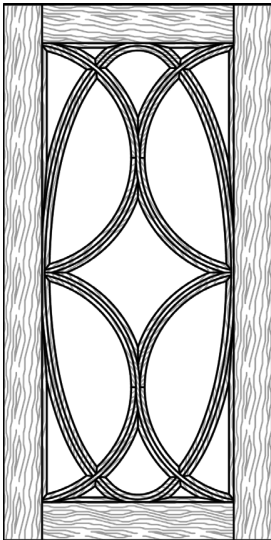

MD422 DOOR

- List Price Per Door \$3125
- Glass Not Included
- Includes Clear Rubber Glass Retainer
- Minimum width 12" - Based On 2 1/4" Stiles
- Minimum height must be two times the width of the door.
- Limitations apply to this mullion pattern for applied molding doorstyles. Request Quote.
- Doors over 60" Tall or over 14 square feet may incur additional charges. Request Quote.

INSET DOOR HINGE OPTIONS

INSET HINGES



NON-MORTISED INSET FURNITURE HINGE - MINARET TIP

- Hafele 351.86.XXX
- Includes Magnetic Catch to keep door closed.
- Available in the following finishes:

351.86.120	Antique Brass
351.86.130	Dark Oil Rubbed Bronze
351.86.190	Copper Bronze
351.86.210	Chrome
351.86.310	Satin Black
351.86.410	Satin Chrome
351.86.610	Matte Nickel
351.86.810	Polished Brass
351.86.910	Pewter

- Add \$84 List Per Door



NON-MORTISED INSET FURNITURE HINGE - BALL TIP

- Hafele 351.86.XXX
- Includes Magnetic Catch to keep door closed.
- Available in the following finishes:

351.86.160	Antique Brass
351.86.170	Dark Oil Rubbed Bronze
351.86.195	Copper Bronze
351.86.230	Chrome
351.86.330	Satin Black
351.86.430	Satin Chrome
351.86.630	Matte Nickel
351.86.830	Polished Brass
351.86.930	Pewter

- Add \$84 List Per Door

MORTISED INSET HINGE

- Mortised Hinges are available as a factory installed option, but must be supplied by the dealer.
- Hinge must be approved by the factory before ordering.
- Includes Magnetic Catch to keep door closed.

- Add \$167 List Per Door.

DOOR STYLES

STAINLESS STEEL DOORS

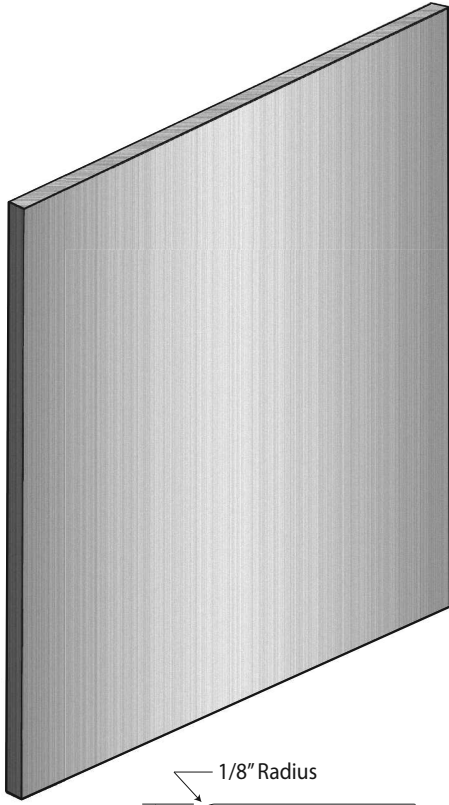

- List Price Per Door \$695 Each
- Doors are constructed of 20 gauge commercial grade 304 stainless steel with a brushed finish and a melamine backing.
- All doors are $\frac{3}{4}$ " thick.
- Grain finish direction is vertical except where indicated. Horizontal grain available by request.

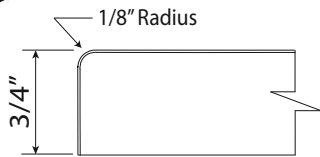

DOOR STYLES

GLASS INSERTS

	INSTALLED WITH RUBBER RETAINER	INSTALLED WITH WOOD RETAINER MOLDING	INSTALLED WITH MATCHING 1/4" PANEL TO COVER MIRROR BACK
1/4" CLEAR GLASS	Not Available	\$228 Per Sq. Foot	Not Applicable
1/8" CLEAR GLASS	\$58 Per Sq. Foot	\$158 Per Sq. Foot	Not Applicable
1/4" MIRROR	Not Available	\$184 Per Sq. Foot	\$134 Per Sq. Foot
1/8" MIRROR	\$70 Per Sq. Foot	\$170 Per Sq. Foot	\$120 Per Sq. Foot

FOR GLASS SHELVES - SEE ACCESSORIES SECTION 9.0

CALCULATING GLASS SIZES

Here is the formula used to calculate the width/height of square or rectangular shaped glass to fit a single opening frame with straight stile & rail parts:

- Glass Width = [Door Width - (stile width x 2)] + [$\frac{3}{8}$ " (GRF width) x 2] - [$\frac{1}{16}$ " (Frame / Glass Gap Width) x 2]
- Glass Height = [Door Height - (rail width x 2)] + [$\frac{3}{8}$ " (GRF width) x 2] - [$\frac{1}{16}$ " (Frame / Glass Gap Width) x 2]

Note: We do not calculate glass size for frame & mullion doors with true divided lites or frame only doors with shaped stiles or rails. For these styles we recommend waiting until you receive your door, then take it to your local glass supplier to have your glass cut to fit each opening.

DOOR STYLES

GLASS RETAINERS

CLEAR RUBBER GLASS RETAINER



All of our Prep for Glass Doors or Mullion Doors include clear rubber glass retainer at no additional charge. Clear rubber glass retainer works only with 1/8" thick inserts.

If ordered with glass doors	N/C
If ordered separately	\$7 Per Ft (10 Ft Min.)

WOOD RETAINER MOLDING

Matching wood glass retainer molding can be ordered with all of our Prep For Glass and Mullion Doors. Unless ordered with glass inserts, it is sent loose in 93" Lengths with #10 Nickel Screws for field installation.

- Molding #315-08 - For 1/8" Glass

\$224 Per 93" Length

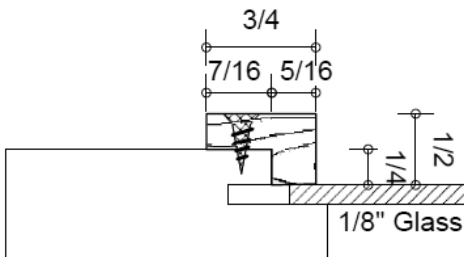

- Molding #316-08 - For 1/4" Glass

\$224 Per 93" Length

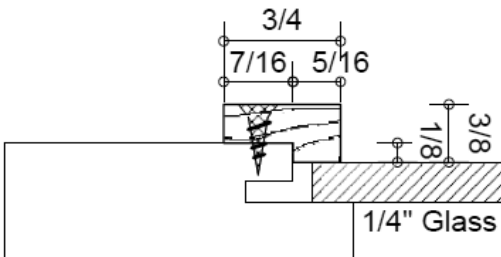

- Molding #317-08-Adjustable

\$224 Per 93" Length

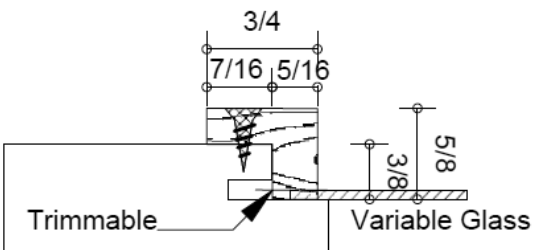

DOOR OVERLAYS

ARTISAN OVERLAY

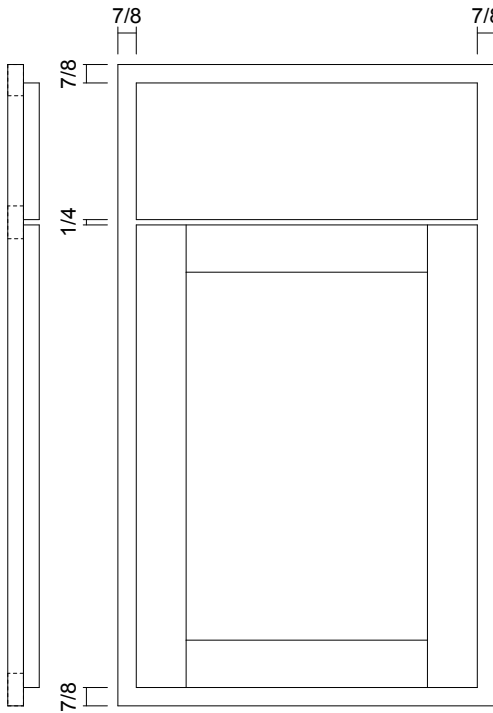

- Uses fully concealed Blum Blumotion 110-Degree Opening as standard.
- Base Price - No Upcharge

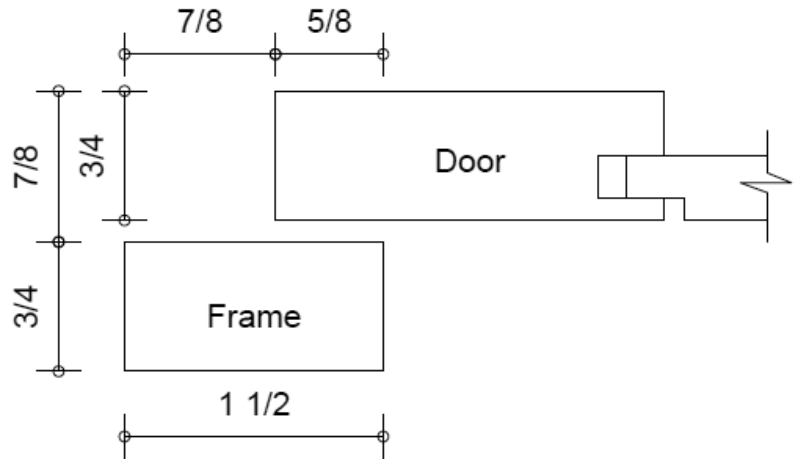

PLAIN INSET

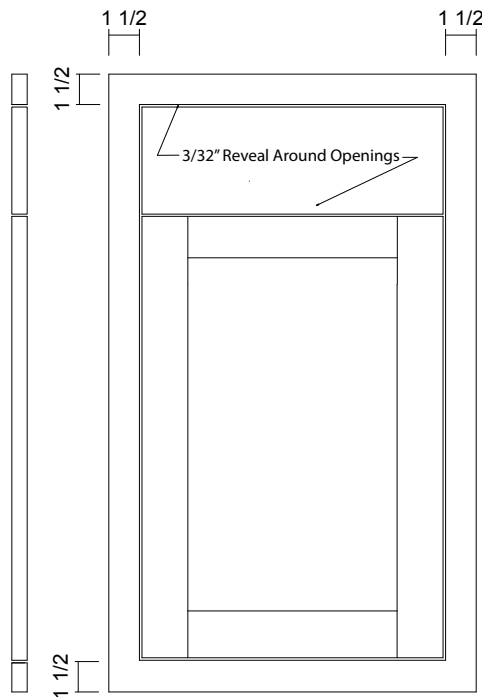

- Uses fully concealed Blum Blumotion 110-Degree Opening as standard.
- Upcharge - Add 10%

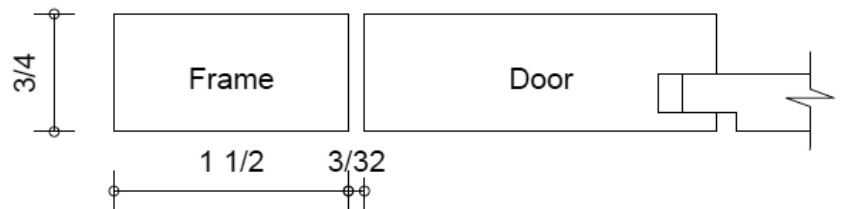

DOOR OVERLAYS

BEADED INSET

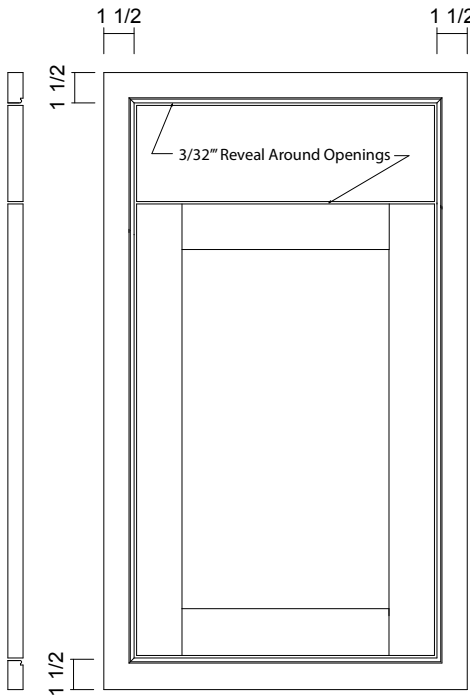

- Uses fully concealed Blum Blumotion 110-Degree Opening as standard.
- Upcharge - Add 17%

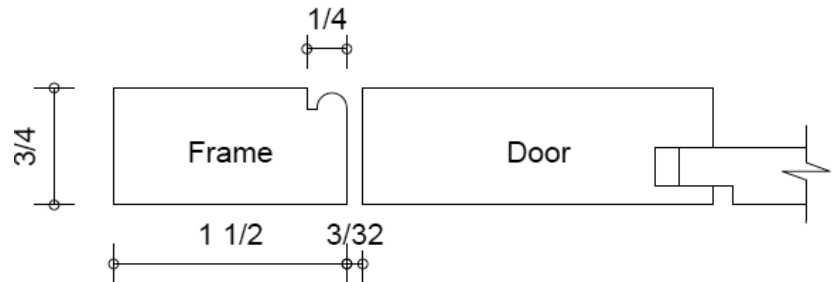

SQUARE BEADED INSET

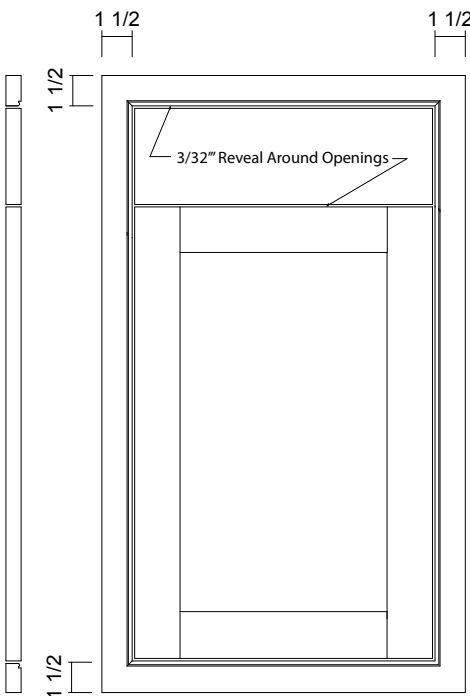

- Uses fully concealed Blum Blumotion 110-Degree Opening as standard.
- Upcharge - Add 17%

